

puris
4life

spirit of bathrooms



2020/2021

ROUNDS · MODERN LIFE · XPRESSION · 4LANDA · ASPEKT · SLIM LINE · KAO LINE · FINE LINE · ICE LINE · BRILLANT · VARIADO 2.0 · SWING · CRESCENDO · STAR LINE · CLASSIC LINE · COOL LINE



puris
4life





puris
4life





Griffeleiste - chrom / alu matt / schwarz matt
strip handle - chrome / alu matt / black matt
profilé poignée - chrome / alu mat / noir mat
greetplijst - chroom / alu mat / zwart mat



Glas-Waschtisch - optiwhite / optiwhite matt / schwarz matt
glass washbasin - optiwhite / optiwhite matt / black matt
plan vasque en verre - optiwhite / optiwhite mat / noir mat
glazen wastafel - optiwhite / optiwhite mat / zwart mat

STONEPLUS®

STONEPLUS® Waschtisch, weiß
STONEPLUS® washbasin, white
STONEPLUS® plan vasque, blanc
STONEPLUS® wastafel, wit

➤ „Málaga“ Keramik-Aufsatzwaschtisch, weiß
“Málaga” ceramic top-mounted washbasin, white
«Málaga» vasque à poser en céramique, blanc
“Málaga” keramische opzetwastafel, wit

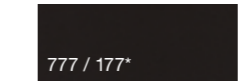

777 / 177*
Cosmos grey matt
cosmos grey matt
cosmos grey mat
cosmos grey mat

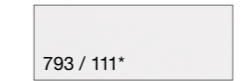

793 / 111*
Edelweiß matt / Weiß matt
noble white matt / white matt
blanc pur mat / blanc mat
edelwit mat / wit mat

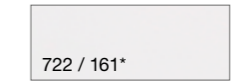

722 / 161*
Polarweiß hgl. / Weiß hgl.
polarwhite hgl. / white hgl.
blanc polaire haute brillance /
blanc haute brillance
hoogglans wit



785 / 185*
Eiche natur Nachbildung
natural oak effect
imitation chêne naturel
eiken naturel folie

Frontdekore / Korpusdekore
Front finishes / Carcass colours
Façades / Corps de meuble
Front kleuren / Corpus kleuren

* = Waschtischplattendekore / Abdeckplattendekore
* = washbasin top colours / top cover colours
* = coloris plan de toilette pour vasque à poser et coloris de plateaux de recouvrement
* = wastafelplaat kleuren / afdekblad kleuren



174
Hunton Eiche
hunton oak
chêne Hunton
hunton eiken



170
Halifax Eiche
halifax oak
chêne Halifax
halifax eiken

Hunton Eiche (174) und Halifax Eiche (170), nur
Waschtischplatten- und Abdeckplattendekore.
Hunton oak (174) and halifax oak (170) only
washbasin plate and top cover colour.

Chêne Hunton (174) et chêne Halifax (170) seulement coloris plan de toilette pour vasque à poser et coloris de plateaux de recouvrement.

Hunton eiken (174) en halifax eiken (170) alleen wastafelplaat en afdekblad kleur.

Kollektion **MODERN LIFE** *by*
Maja Prinzessin von Hohenzollern



puris
4life



„Modern Life“ by Maja Prinzessin von Hohenzollern ist eine nachhaltige Design-Line mit klaren Strukturen. Das Konzept verbindet warme Naturtöne mit trendigen Oberflächen. Dadurch entsteht eine wohnliche und ebenso moderne Atmosphäre.

“Modern Life” by Maja Princess of Hohenzollern is a sustainable design with clear features. The concept combines warm natural tones with trendy surfaces. This creates a homely yet equally modern atmosphere.

«Modern Life» ,by Maja Princesse de Hohenzollern, est une ligne de design durable avec des structures claires. Le concept combine des tons chauds de la nature et des surfaces à la mode. Cela crée une atmosphère confortable et tout aussi moderne.

“Modern Life“ door Maja Princess of Hohenzollern is een duurzame ontwerplijn met heldere structuren. Het concept combineert warme natuur tinten met trendy oppervlakken. Dit zorgt voor een huiselijke en even moderne sfeer.





puris
4life





Push to open
push to open
push to open
push to open



Griffleiste - chrom / alu matt / schwarz matt
strip handle - chrome / alu matt / black matt
profilé poignée - chrome / alu mat / noir mat
greetplijst - chroom / alu mat / zwart mat



„Ideal Standard CONNECT AIR“
Keramik-Aufsatzwaschtisch, weiß
ceramic top-mounted washbasin, white
vasque à poser en céramique, blanc
keramische opzetwastafel, wit



„Málaga“ Keramik-Aufsatzwaschtisch, weiß
"Málaga" ceramic top-mounted washbasin, white
«Málaga» vasque à poser en céramique, blanc
"Málaga" keramische opzetwastafel, wit

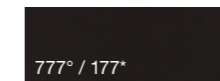

777° / 177*
Cosmos grey matt
cosmos grey matt
cosmos grey mat

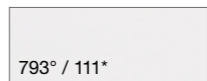

793° / 111*
Edelweiß matt / Weiß matt
noble white matt / white matt
blanc pur mat / blanc mat
edelwit mat / wit mat



891° / 191*
Quarzgrau matt
quartz grey matt
gris quartz mat
kwartsgrijs mat

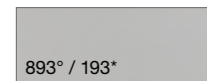

893° / 193*
Titangrau matt
titanium grey matt
titane gris mat
titanium grijs mat

Frontdekore / Korpusdekore /
Wandverkleidungsdekore
Front finishes / Carcass colours /
Wall covering colours
Façades / Corps de meuble /
Coloris de crédence
Front kleuren / Corpus kleuren /
Gevelbekleding kleuren

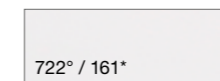

722° / 161*
Polarweiß hgl. / Weiß hgl.
polarwhite hgl. / white hgl.
blanc polaire haute brillance /
blanc haute brillance
hoogglans wit

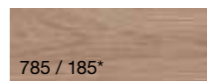

785 / 185*
Eiche natur Nachbildung
natural oak effect
imitation chêne naturel
eiken naturel folie

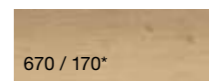

670 / 170*
Halifax Eiche
halifax oak
chêne Halifax
halifax eiken

Hunton Eiche (174) nur Waschtischplatten- und
Abdeckplattendekor.
Hunton oak (174) only washbasin plate and top
cover colour.



174
Hunton Eiche
hunton oak
chêne Hunton
hunton eiken

Chêne Hunton (174) seulement coloris plan de
toilette pour vasque à poser et coloris de pla-
teaux de recouvrement.
Hunton eiken (174) alleen wastafelplaat en
afdekblad kleur.

° = Dekorstreifen
° = accent colours
° = décor avec mise en relief
° = accentdecors

* = Waschtischplatten- / Abdeckplattendekore
* = washbasin top colours / top cover colours
* = coloris plan de toilette pour vasque à poser / coloris de plateaux de recouvrement
* = wastafelplaat kleuren / afdekblad kleuren



Badmöbelkombinationen in 666, 966, 1066, 1266, 1366 und 1566 mm Breite erhältlich. 1266 mm Breite auch als Doppelwaschtisch möglich.
Bathroom furniture combinations available in widths 666, 966, 1066, 1266, 1366 and 1566 mm. Width 1266 mm, also available as double washbasin.
Compositions de salle de bains disponibles en largeur de 666, 966, 1066, 1266, 1366 et 1566 mm. Largeur de 1266 mm également comme plan double vasque.
Badkamermeubelcombinaties in 666, 966, 1066, 1266, 1366 en 1566 mm breed verkrijgbaar. 1266 mm breed ook als dubbele wastafel mogelijk.



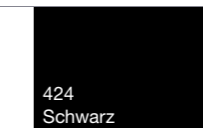
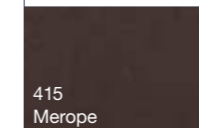
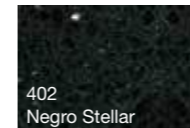
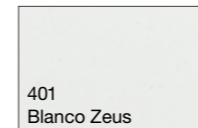

Griffprofil alu / schwarz
handle profile alu / black
profil de poignée alu / noir
griepprofiel alu / zwart



„Ideal Standard CONNECT AIR“
Keramik-Aufsatzwaschtisch, weiß
ceramic top-mounted washbasin, white
vasque à poser en céramique, blanc
keramische opzetwastafel, wit



Mineralguss-Aufsatzwaschtisch, weiß*
cast mineral top-mounted washbasin, white*
vasque à poser en matériau de synthèse, blanc*
minerale opzetwastafel, wit*

*Waschtisch in verschiedenen Größen erhältlich.
*Washbasin is available in different sizes.
*La vasque à poser est livrable en dimensions différentes.
*Wastafel is verkrijgbaar in verschillende afmetingen.

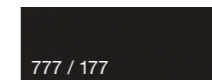

Cosmos grey matt
cosmos grey matt
cosmos grey mat
cosmos grey mat



Quarzgrau matt
quartz grey matt
gris quartz mat
kwartsgrijs mat

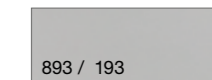

Titangrau matt
titanium grey matt
titane gris mat
titanium grijs mat

Frontdekore / Korpusdekore
Front finishes / Carcass colours
Façades / Corps de meuble
Front kleuren / Corpus kleuren

* = Waschtischplattendekore
* = washbasin top colours
* = coloris plans de toilette pour
* = vasque à poser
* = wastafelplaat kleuren



Polarweiß hgl. / Weiß hgl.
polarwhite hgl. / white hgl.
blanc polaire haute brillance /
blanc haute brillance
hooggilans wit



Halifax Eiche
halifax oak
chêne Halifax
halifax eiken



Eiche natur Nachbildung
natural oak effect
imitation chêne naturel
eiken naturel folie

Badmöbelkombinationen in 626, 926, 1226 und 1426 mm Breite erhältlich. 1426 mm Breite ausschließlich mit 2 Waschtischen möglich. Waschtischplatten in Frontdekor oder in „Qsolid“.
Bathroom furniture combinations available in widths 626, 926, 1226 and 1426 mm. Width 1426 mm, only with 2 washbasins. Washbasin tops in front colour or in „Qsolid“.
Compositions de salle de bains disponibles en largeur de 626, 926, 1266 et 1426 mm. Largeur de 1426 mm seulement avec 2 plans vasques. Plans de toilette pour vasques à poser sont disponible en couleur du façades ou en „Qsolid“.
Badkamermeubelcombinaties in 626, 926, 1226 en 1426 mm breed verkrijgbaar. 1426 mm breed alleen met 2 wastafels. Wastafel platen in front kleuren en „Qsolid“.



puris
4life

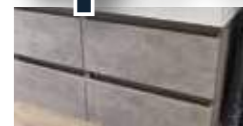

Griffleiste - chrom / alu matt / schwarz matt
strip handle - chrome / alu matt / black matt
profilé poignée - chrome / alu mat / noir mat
greetplijst - chroom / alu mat / zwart mat

Griffprofil in Korpusdekor
handle profile in Carcass colour
profil de poignée en coloris de corps
greetprofiel in corpus kleur



„Squared“ Keramik-Waschtisch, weiß
“Squared“ ceramic washbasin, white
„Squared“ plan vasque céramique, blanc
“Squared“ keramische wastafel, wit

„Till“ Keramik-Waschtisch, weiß
“Till“ ceramic washbasin, white
„Till“ plan vasque céramique, blanc
“Till“ keramische wastafel, wit

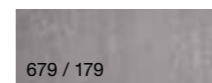

679 / 179
Betonoptik
concrete effect
aspect béton
betonoptiek

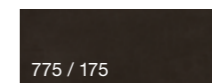

775 / 175
Stahl dunkel matt
steel grey dark matt
acier sombre mat
staal donker mat

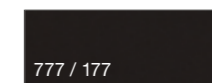

777 / 177
Cosmos grey matt
cosmos grey matt
cosmos grey mat
cosmos grey mat



891 / 191
Quarzgrau matt
quartz grey matt
gris quartz mat
kwartsgrijs mat



670 / 170
Halifax Eiche
halifax oak
chêne Halifax
halifax eiken

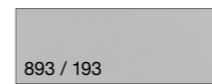

893 / 193
Titangrau matt
titanium grey matt
titane gris mat
titanium grijs mat



787 / 187
Lack Weiß hgl.
white lacquer hgl.
laqué blanc haute brillance
hoogglans lak wit

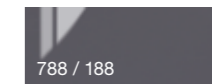

788 / 188
Lack Grau hgl.
grey lacquer hgl.
laqué gris haute brillance
hoogglans lak grijs

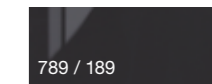

789 / 189
Lack Karbon hgl.
carbon lacquer hgl.
laqué carbone haute brillance
hoogglans lak carbon



680 / 180
Charleston Eiche
charleston oak
chêne Charleston
charleston eiken

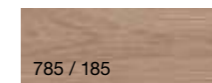

785 / 185
Eiche natur Nachbildung
natural oak effect
imitation chêne naturel
eiken naturel folie



786 / 186
Eiche Trüffel
truffle oak
chêne truffier
eiken truffel

Badmöbelkombinationen in 620, 810, 1020 und 1220 mm Breite erhältlich. 1020 mm Breite auch als Doppelwaschtisch möglich.
„Squared“: 1220 mm Breite auch als Doppelwaschtisch möglich. „Till“: 1220 mm Breite ausschließlich als Doppelwaschtisch möglich.
Bathroom furniture combinations available in widths 620, 810, 1020 and 1220 mm. Width 1020 mm also available as double washbasin.
„Squared“: Width 1220 mm also available as double washbasin. „Till“: Width 1220 mm, only as double washbasin.
Compositions de salle de bains disponibles en largeur de 620, 810, 1020 et 1220 mm. Largeur de 1020 mm également comme plan double vasque.
„Squared“: Largeur de 1220 mm également comme plan double vasque. „Till“: Largeur de 1220 mm seulement comme plan double vasque.
Badkamermeubelcombinaties in 620, 810, 1020 en 1220 mm breed verkrijgbaar. 1220 mm breed ook als dubbele wastafel mogelijk.
„Squared“: 1220 mm breed ook als dubbele wastafel mogelijk. „Till“: 1220 mm breed alleen als dubbele wastafel mogelijk.



puris
4life



Griffleiste - chrom / alu matt / schwarz matt
strip handle - chrome / alu matt / black matt
profilé poignée - chrome / alu mat / noir mat
greeplijst - chrom / alu mat / zwart mat



„Squared“ Keramik-Aufsatzwaschtisch - Carbone matt / weiß
“Squared“ ceramic top-mounted washbasin - carbon matt / white
«Squared» vasque à poser en céramique - carbone mat / blanc
“Squared“ keramische opzetwastafel - carbon mat / wit



Mineralguss-Aufsatzwaschtisch, weiß
cast mineral top-mounted washbasin, white
vasque à poser en matériau de synthèse, blanc
minerale opzetwastafel, wit



777 / 177*

Cosmos grey matt
cosmos grey matt
cosmos grey mat
cosmos grey mat

891 / 191*

Quarzgrau matt
quarz grey matt
gris quartz mat
kwartgrijs mat

893 / 193*

Titangrau matt
titanium grey matt
titane gris mat
titanium grijs mat

Frontdekore / Korpusdekore
Front finishes / Carcass colours
Façades / Corps de meuble
Front kleuren / Corpus kleuren
* = Waschtischplattendekore / Abdeckplattendekore
* = washbasin top colours / top cover colours
* = coloris plan de toilette pour vasque à poser /
coloris de plateaux de recouvrement
* = wastafelplaat kleuren / afdekblad kleuren

793 / 111*

Edelweiß matt / Weiß matt
noble white matt / white matt
blanc pur mat / blanc mat
edelwit mat / wit mat

722 / 161

Polarweiß hgl. / Weiß hgl.
polarwhite hgl. / white hgl.
blanc polaire haute brillance /
blanc haute brillance
hoogglans wit

794 / 194*

Eiche Sand
sand oak
chêne sable
zand eiken

174

Hunton Eiche
hunton oak
chêne Hunton
hunton eiken

Hunton Eiche (174) nur Waschtischplatten- und
Abdeckplattendekor.

Hunton oak (174) only washbasin plate and
top cover colour.

Chêne Hunton (174) seulement coloris plan de toilette pour
vasque à poser et coloris de plateaux de
recouvrement.

Hunton eiken (174) alleen wastafelplaat en
afdekblad kleur.

Badmöbelkombinationen von 606 bis 1546 mm. Breite erhältlich. Alle Waschtische erhältlich in verschiedenen Größen.
Bathroom furniture combinations available in widths from 606 to 1546 mm. All Washbasins are available in different sizes.
Compositions de salle de bains disponibles en largeur de 606 à 1546 mm. Toutes les vasques sont livrables en dimensions différentes.
Backamerubelcombinaties van 606 tot 1546 mm breed verkrijgbaar. Alle wastafels zijn verkrijgbaar in verschillende afmetingen.

SLIM LINE



puris
4life





puris
4life



grifflos
handleless
sans poignée
grieploos



Griffleiste - chrom / alu matt / schwarz matt
strip handle - chrome / alu matt / black matt
profilé poignée - chrome / alu mat / noir mat
grieplijst - chrom / alu mat / zwart mat



SLIM LINE



STONEPLUS® Waschtisch, weiß
STONEPLUS® washbasin, white
STONEPLUS® plan vasque, blanc
STONEPLUS® wastafel, wit



STONEPLUS®

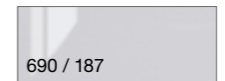

Lack Weiß hgl.
white lacquer hgl.
laqué blanc haute brillance
hoogglans lak wit

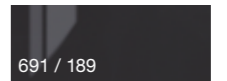

Lack Karbon hgl.
carbon lacquer hgl.
laqué carbone haute brillance
hoogglans lak carbon



Eiche Sand
sand oak
chêne sable
zand eiken



Charleston Eiche
charleston oak
chêne Charleston
charleston eiken

Frontdekore / Korpusdekore
Front finishes / Carcass colours
Façades / Corps de meuble
Front kleuren / Corpus kleuren

Badmöbelkombinationen in 612, 912 und 1212 mm Breite erhältlich.
Bathroom furniture combinations available in widths 612, 912 and 1212 mm.
Compositions de salle de bains disponibles en largeur de 612, 912 et 1212 mm.
Badkamermeubelcombinaties in 612, 912 en 1212 mm breed verkrijgbaar.



puris
4life



Griffleiste alu matt
strip handle alu matt
profilé poignée alu mat
greeklijst alu mat



Stangengriff chrom
handle chrome
poignée barre chrome
stangengreep chrom

➤ Keramik-Waschtisch, weiß
ceramic washbasin, white
plan vasque céramique, blanc
keramische wastafel, wit



764 / 164

Steingrau matt
stonegrey matt
gris pierre mat
steengrijs mat

777 / 177

Cosmos grey matt
cosmos grey matt
cosmos grey mat
cosmos grey mat

793 / 111

Edelweiß matt / Weiß matt
noble white matt / white matt
blanc pur mat / blanc mat
edelwit mat / wit mat

Frontdekore / Korpusdekore
Front finishes / Carcass colours
Façades / Corps de meuble
Front kleuren / Corpus kleuren

891 / 191

Quarzgrau matt
quartz grey matt
gris quartz mat
kwartsgrijs mat

893 / 193

Titangrau matt
titanium grey matt
titane gris mat
titanium grijs mat

686 / 121

Anthrazit hgl.
anthracite hgl.
anthracite haute brillance
hoogglans antraciet

722 / 161

Polarweiß hgl. / Weiß hgl.
polarwhite hgl. / white hgl.
blanc polaire haute brillance /
blanc haute brillance
hoogglans wit

680 / 180

Charleston Eiche
charleston oak
chêne Charleston
charleston eiken

784 / 184

Eiche hell Nachbildung
light oak effect
imitation chêne clair
licht eiken folie

785 / 185

Eiche natur Nachbildung
natural oak effect
imitation chêne naturel
eiken naturel folie

786 / 186

Eiche Trüffel
truffle oak
chêne truffier
eiken truffel

794 / 194

Eiche Sand
sand oak
chêne sable
zand eiken

792 / 192

Ulme Nachbildung
elm imitation
imitation orme
iepen hout folie

769 / 169

Hacienda Grau
hacienda grey
gris exotique
hacienda grijs



Badmöbelkombinationen in 660, 860, 960, 1060 und 1260 mm Breite erhältlich. 1260 mm Breite auch als Doppelwaschtisch möglich.
Bathroom furniture combinations available in widths 660, 860, 960, 1060 and 1260 mm. Width 1260 mm also available as double washbasin.
Compositions de salle de bains disponibles en largeur de 660, 860, 960, 1060 et 1260 mm. Largeur de 1260 mm également comme plan double vasque.
Badkamermeubelcombinaties in 660, 860, 960, 1060 en 1260 mm breed verkrijgbaar. 1260 mm breed ook als dubbele wastafel mogelijk.



puris
4life



Stangengriff chrom
handle chrome
poignée barre chrome
stangengreep chrom



Keramik-Waschtisch, weiß
ceramic washbasin, white
plan vasque céramique, blanc
keramische wastafel, wit



STONEPLUS® Waschtisch, weiß
STONEPLUS® washbasin, white
STONEPLUS® plan vasque, blanc
STONEPLUS® wastafel, wit

STONEPLUS®

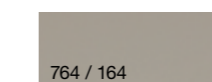

764 / 164
Steingrau matt
stonegrey matt
gris pierre mat
steengrijs mat

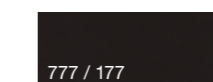

777 / 177
Cosmos grey matt
cosmos grey matt
cosmos grey mat
cosmos grey mat

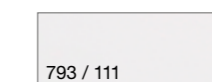

793 / 111
Edelweiß matt / Weiß matt
noble white matt / white matt
blanc pur mat / blanc mat
edelwit mat / wit mat

Frontdekore / Korpusdekore
Front finishes / Carcass colours
Façades / Corps de meuble
Front kleuren / Corpus kleuren



891 / 191
Quarzgrau matt
quartz grey matt
gris quartz mat
kwartsgrijs mat

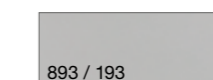

893 / 193
Titangrau matt
titanium grey matt
titane gris mat
titanium grijs mat

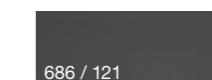

686 / 121
Anthrazit hgl.
anthracite hgl.
anthracite haute brillance
hoogglans antraciet

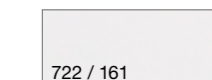

722 / 161
Polarweiß hgl. / Weiß hgl.
polarwhite hgl. / white hgl.
blanc polaire haute brillance /
blanc haute brillance
hoogglans wit



680 / 180
Charleston Eiche
charleston oak
chêne Charleston
charleston eiken

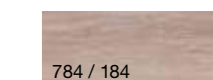

784 / 184
Eiche hell Nachbildung
light oak effect
imitation chêne clair
licht eiken folie

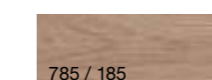

785 / 185
Eiche natur Nachbildung
natural oak effect
imitation chêne naturel
eiken naturel folie



786 / 186
Eiche Trüffel
truffle oak
chêne truffier
eiken truffel



794 / 194
Eiche Sand
sand oak
chêne sable
zand eiken



792 / 192
Ulme Nachbildung
elm imitation
imitation orme
iepen hout folie



755 / 155
Hacienda Schwarz
hacienda black
noir exotique
hacienda zwart

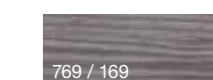

769 / 169
Hacienda Grau
hacienda grey
gris exotique
hacienda grijs



Badmöbelkombinationen in 620, 920 und 1220 mm Breite erhältlich. Keramik-Waschtisch: 650, 950 und 1250 mm Breite
Bathroom furniture combinations available in widths 620, 920 and 1220 mm. Ceramic washbasin: width 650, 950 and 1250 mm
Compositions de salle de bains disponibles en largeur de 620, 920 et 1220 mm. Plan vasque céramique: 650, 950 et 1250 mm largeur
Badkamemeubelcombinaties in 620, 920 en 1220 mm breed verkrijgbaar. Keramische wastafel: 650, 950 en 1250 mm breed



Push to open
push to open
push to open
push to open

Griffleiste - chrom / alu matt / schwarz matt
strip handle - chrome / alu matt / black matt
profilé poignée - chrome / alu mat / noir mat
greetpijst - chroom / alu mat / zwart mat



heizbar
heated
miroir chauffant
spiegelverwarming



Glas-Waschtisch - optiwhite / optiwhite matt
glass washbasin - optiwhite / optiwhite matt
plan vasque en verre - optiwhite / optiwhite mat
glazen wastafel - optiwhite / optiwhite mat

STONEPLUS® Waschtisch, weiß
STONEPLUS® washbasin, white
STONEPLUS® plan vasque, blanc
STONEPLUS® wastafel, wit

STONEPLUS®



heizbar
heated
miroir chauffant
spiegelverwarming

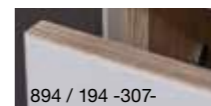

894 / 194 -307-
Glas Optiwhite matt
glass optiwhite matt
verre optiwhite mat
glas optiwhite mat



895 / 194 -310-
Glas Grau matt
glass grey matt
verre gris mat
glas grijs mat



794*
Eiche Sand
sand oak
chêne sable
zand eiken

Frontdekore / Korpusdekore
Front finishes / Carcass colours
Façades / Corps de meuble
Front kleuren / Corpus kleuren

*nur Frontdekor
*only front finish
*seulement façade
*alleen front kleur

Badmübelkombinationen in 620, 920 und 1220 mm Breite erhältlich. 1220 mm Breite auch als Doppelwaschtisch möglich. Alle Korpusdekore bestehend aus Korpusdekor Eiche Sand (194) mit Sichtseitendekor Glas (-307- oder -310-).
Bathroom furniture combinations available in widths 620, 920 and 1220 mm. Width 1220 mm also available as double washbasin. All Carcass finishes consist of the Carcass finish sand oak (194) with visible side finish in glass (-307- or -310-).
Compositions de salle de bains disponibles en largeur de 620, 920 et 1220 mm. Largeur de 1220 mm également comme plan double vasque. Tous les décors corps avec décor côtés chêne sable (194) avec décor côtés visibles verre (-307- ou -310-).
Badkamermeubelcombinaties in 620, 920 en 1220 mm breed verkrijgbaar. 1220 mm breed ook als dubbele wastafel mogelijk. De glazen corpus (-307- en -310-) hebben een zand eiken (194) binnen en rand afwerking.



Stangengriff chrom + chrom matt
handle chrome + chrome matt
poignée barre chrome + chrome mat
stangengreep chrom + chromo mat



evermite®



Glas-Waschtisch - optiwhite / quarzitgrau
glass washbasin - optiwhite / quartzite grey
plan vasque en verre - optiwhite / gris quartzite
glazen wastafel - optiwhite / kwartsiet grijs

evermite® Waschtisch, weiß
evermite® washbasin, white
evermite® plan vasque, blanc
evermite® wastafel, wit

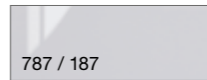

Lack Weiß hgl.
white lacquer hgl.
laqué blanc haute brillance
hoogglans lak wit



Lack Grau hgl.
grey lacquer hgl.
laqué gris haute brillance
hoogglans lak grijs

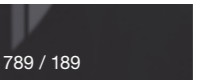

Lack Karbon hgl.
carbon lacquer hgl.
laqué carbone haute brillance
hoogglans lak carbon

Frontdekore / Korpusdekore
Front finishes / Carcass colours
Façades / Corps de meuble
Front kleuren / Corpus kleuren

Badmöbelkombinationen in 606, 906 und 1206 mm Breite erhältlich. 1206 mm Breite auch als Doppelwaschtisch möglich.
Bathroom furniture combinations available in widths 606, 906 and 1206 mm. Width 1206 mm also available as double washbasin.
Compositions de salle de bains disponibles en largeur de 606, 906 et 1206 mm. Largeur de 1206 mm également comme plan double vasque.
Badkamermeubelcombinaties in 606, 906 en 1206 mm breed verkrijgbaar. 1206 mm breed ook als dubbele wastafel mogelijk.





puris
4life



129
Chrom
chrome
chromé
chrom



164
Steingrau matt
stonegrey matt
gris pierre mat
steengrijs mat



177
Cosmos grey matt
cosmos grey matt
cosmos grey mat
cosmos grey mat

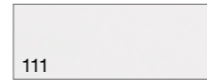

111
Weiß matt
white matt
blanc mat
wit mat

Dekorline Zwischenplatte
Dekorline board
Liseré décoratif
Decor blad

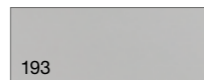

193
Titangrau matt
titanium grey matt
titane gris mat
titanium grijs mat



191
Quarzgrau matt
quartz grey matt
gris quartz mat
kwartsgrijs mat



121
Anthrazit hgl.
anthracite hgl.
anthracite haute brillance
hoogglans antraciet

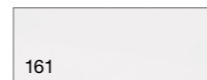

161
Weiß hgl.
white hgl.
blanc haute brillance
hoogglans wit



180
Charleston Eiche
charleston oak
chêne Charleston
charleston eiken



184
Eiche hell Nachbildung
light oak effect
imitation chêne clair
licht eiken folie



185
Eiche natur Nachbildung
natural oak effect
imitation chêne naturel
eiken naturel folie



186
Eiche Trüffel
truffle oak
chêne truffier
eiken truffel



194
Eiche Sand
sand oak
chêne sable
zand eiken



192
Ulme Nachbildung
elm imitation
imitation orme
iepen hout folie



155
Hacienda Schwarz
hacienda black
noir exotique
hacienda zwart



169
Hacienda Grau
hacienda grey
gris exotique
hacienda grijs



STONEPLUS® Waschtisch, weiß
STONEPLUS® washbasin, white
STONEPLUS® plan vasque, blanc
STONEPLUS® wastafel, wit



Stangengriff chrom
handle chrome
poignée barre chrome
stangengreep chrom



Stangengriff chrom
handle chrome
poignée barre chrome
stangengreep chrom



Stangengriff chrom + chrom matt
handle chrome + chrome matt
poignée barre chrome + chrome mat
stangengreep chrom + chrom mat



Keramik-Waschtisch, weiß
ceramic washbasin, white
plan vasque en céramique, blanc
keramische wastafel, wit



Glas-Waschtisch - optiwhite / quarzitgrau / optiwhite matt
glass washbasin - optiwhite / quartzite grey / optiwhite matt
plan vasque en verre - optiwhite / gris quartzite / optiwhite mat
glazen wastafel - optiwhite / kwartsiet grijs / optiwhite mat

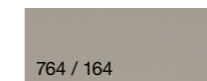

764 / 164
Steingrau matt
stonegrey matt
gris pierre mat
steengrijs mat

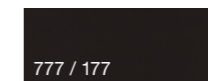

777 / 177
Cosmos grey matt
cosmos grey matt
cosmos grey mat
cosmos grey mat



793 / 111
Edelweiß matt / Weiß matt
noble white matt / white matt
blanc pur mat / blanc mat
edelwit mat / wit mat

Frontdekore / Korpusdekore
Front finishes / Carcass colours
Façades / Corps de meuble
Front kleuren / Corpus kleuren

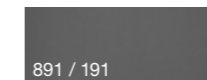

891 / 191
Quarzgrau matt
quartz grey matt
gris quartz mat
kwartsgrijs mat

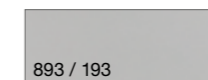

893 / 193
Titangrau matt
titanium grey matt
titane gris mat
titanium grijs mat

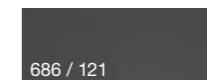

686 / 121
Anthrazit hgl.
anthracite hgl.
anthracite haute brillance
hoogglans antraciet



722 / 161
Polarweiß hgl. / Weiß hgl.
polarwhite hgl. / white hgl.
blanc polaire haute brillance /
blanc haute brillance
hoogglans wit



680 / 180
Charleston Eiche
charleston oak
chêne Charleston
charleston eiken

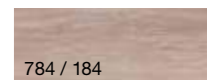

784 / 184
Eiche hell Nachbildung
light oak effect
imitation chêne clair
licht eiken folie

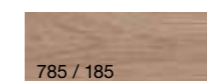

785 / 185
Eiche natur Nachbildung
natural oak effect
imitation chêne naturel
eiken naturel folie



786 / 186
Eiche Trüffel
truffle oak
chêne truffier
eiken truffel



794 / 194
Eiche Sand
sand oak
chêne sable
zand eiken



792 / 192
Ulme Nachbildung
elm imitation
imitation orme
iepen hout folie



755 / 155
Hacienda Schwarz
hacienda black
noir exotique
hacienda zwart

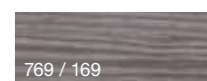

769 / 169
Hacienda Grau
hacienda grey
gris exotique
hacienda grijs

Badmübelkombinationen in 620, 920 und 1220 mm Breite erhältlich. 1220 mm Breite auch als Doppelwaschtisch möglich.
Bathroom furniture combinations available in widths 620, 920 and 1220 mm. Width 1220 mm also available as double washbasin.
Compositions de salle de bains disponibles en largeur de 620, 920 et 1220 mm. Largeur de 1220 mm également comme plan double vasque.
Badkamermöbelcombinaties in 620, 920 en 1220 mm breed verkrijgbaar. 1220 mm breed ook als dubbele wastafel mogelijk.



puris
4life



Stangengriff chrom
handle chrome
poignée barre chrome
stangengreep chrom



Glas-Waschtisch - optiwhite / quarzitgrau
glass washbasin - optiwhite / quartzite grey
plan vasque en verre - optiwhite / gris quartzite
glazen wastafel - optiwhite / kwartsiet grijs



evermite®



evermite® Waschtisch, weiß
evermite® washbasin, white
evermite® plan vasque, blanc
evermite® wastafel, wit

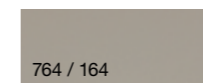

Steingrau matt
stonegrey matt
gris pierre mat
steengrijs mat

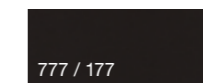

Cosmos grey matt
cosmos grey matt
cosmos grey mat
cosmos grey mat

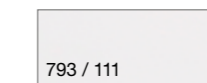

Edelweiß matt / Weiß matt
noble white matt / white matt
blanc pur mat / blanc mat
edelwit mat / wit mat

Frontdekore / Korpusdekore
Front finishes / Carcass colours
Façades / Corps de meuble
Front kleuren / Corpus kleuren

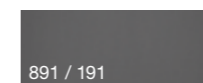

Quarzgrau matt
quartz grey matt
gris quartz mat
kwartsgrijs mat

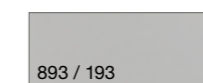

Titangrau matt
titanium grey matt
titane gris mat
titanium grijs mat

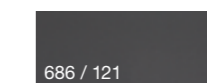

Anthrazit hgl.
anthracite hgl.
anthracite haute brillance
hoogglans antraciet



Polarweiß hgl. / Weiß hgl.
polarwhite hgl. / white hgl.
blanc polaire haute brillance /
blanc haute brillance
hoogglans wit



Charleston Eiche
charleston oak
chêne Charleston
charleston eiken



Eiche hell Nachbildung
light oak effect
imitation chêne clair
licht eiken folie

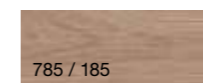

Eiche natur Nachbildung
natural oak effect
imitation chêne naturel
eiken naturel folie



Eiche Trüffel
truffle oak
chêne truffier
eiken truffel



Eiche Sand
sand oak
chêne sable
zand eiken



Ulme Nachbildung
elm imitation
imitation orme
iepen hout folie



Hacienda Schwarz
hacienda black
noir exotique
hacienda zwart



Hacienda Grau
hacienda grey
gris exotique
hacienda grijs

Badmübelkombinationen in 906, 1206, 1406 und 1806 mm Breite erhältlich. 1806 (1812) mm Breite ausschließlich als Doppelwaschtisch möglich. Glas-Waschtisch: 912, 1212, 1412 und 1812 mm Breite
Bathroom furniture combinations available in widths 906, 1206, 1406 and 1806 mm. Width 1806 (1812) mm, only as double washbasin. Glass washbasin: width 912, 1212, 1412 and 1812 mm
Compositions de salle de bains disponibles en largeur de 906, 1206, 1406 et 1806 mm. Largeur de 1806 (1812) mm seulement comme plan double vasque. Plan vasque en verre: 912, 1212, 1412 et 1812 mm largeur
Badkamermeubelcombinaties in 906, 1206, 1406 en 1806 mm breed verkrijgbaar. 1806 (1812) mm breed alleen als dubbele wastafel mogelijk. Glazen wastafel: 912, 1212, 1412 en 1812 mm breed



puris
4life



Stangengriff - chrom (schmal) / chrom (dick)
handle - chrome (narrow) / chrome (expanded)
poignée barre - chrome (étroite) / chrome (large)
stangengreep - chroom (smal) / chroom (breed)

Griffleiste - chrom / alu matt / schwarz matt
strip handle - chrome / alu matt / black matt
profilé poignée - chrome / alu mat / noir mat
greeplijst - chroom / alu mat / zwart mat



Glas-Waschtisch - optiwhite / quarzitgrau
glass washbasin - optiwhite / quartzite grey
plan vasque en verre - optiwhite / gris quartzite
glazen wastafel - optiwhite / kwartsiet grijs



STONEPLUS®



STONEPLUS® Waschtisch, weiß
STONEPLUS® washbasin, white
STONEPLUS® plan vasque, blanc
STONEPLUS® wastafel, wit

evermite®



evermite® Waschtisch, weiß
evermite® washbasin, white
evermite® plan vasque, blanc
evermite® wastafel, wit

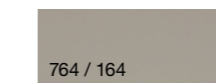

Steingrau matt
stonegrey matt
gris pierre mat
steengrijs mat

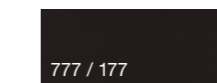

Cosmos grey matt
cosmos grey matt
cosmos grey mat
cosmos grey mat

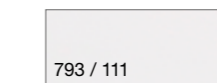

Edelweiß matt / Weiß matt
noble white matt / white matt
blanc pur mat / blanc mat
edelwit mat / wit mat

Frontdekore / Korpusdekore
Front finishes / Carcass colours
Façades / Corps de meuble
Front kleuren / Corpus kleuren

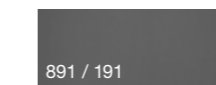

Quarzgrau matt
quartz grey matt
gris quartz mat
kwartsiet grijs mat

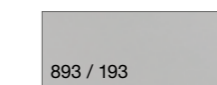

Titangrau matt
titanium grey matt
titane gris mat
titanium grijs mat

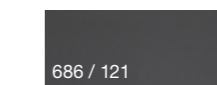

Anthrazit hgl.
anthracite hgl.
anthracite haute brillance
hoogglans antraciet



Polarweiß hgl. / Weiß hgl.
polarwhite hgl. / white hgl.
blanc polaire haute brillance /
blanc haute brillance
hoogglans wit



Charleston Eiche
charleston oak
chêne Charleston
charleston eiken

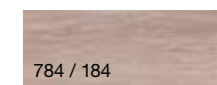

Eiche hell Nachbildung
light oak effect
imitation chêne clair
licht eiken folie

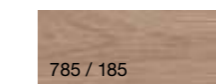

Eiche natur Nachbildung
natural oak effect
imitation chêne naturel
eiken naturel folie



Eiche Trüffel
truffle oak
chêne truffier
eiken truffel

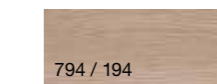

Eiche Sand
sand oak
chêne sable
zand eiken



Ulme Nachbildung
elm imitation
imitation orme
iepen hout folie



Hacienda Schwarz
hacienda black
noir exotique
hacienda zwart

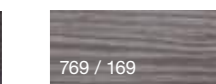

Hacienda Grau
hacienda grey
gris exotique
hacienda grijs

Badmöbelkombinationen in 906, 1206, 1406 und 1606 mm Breite erhältlich. 1206 und 1406 mm Breite auch als Doppelwaschtisch möglich. 1606 mm Breite ausschließlich als Doppelwaschtisch möglich.
Bathroom furniture combinations available in widths 906, 1206, 1406 and 1606 mm. Width 1206 and 1406 mm also available as double washbasin. Width 1606 mm only as double washbasin.
Compositions de salle de bains disponibles en largeur de 906, 1206, 1406 et 1606 mm. Largeur de 1206 et 1406 mm également comme plan double vasque. Largeur de 1606 mm seulement comme plan double vasque.
Badkamermeubelcombinaties in 906, 1206, 1406 en 1606 mm breed verkrijgbaar. 1206 en 1406 mm breed ook leverbaar met 2 kraanegaten of als dubbele wastafel. 1606 mm breed alleen leverbaar met 2 kraanegaten of als dubbele wastafel.



Stangengriff chrom
handle chrome
poignée barre chrome
stangengreep chrom



Glas-Waschtisch - optiwhite / quarzitgrau
glass washbasin - optiwhite / quartzite grey
plan vasque en verre - optiwhite / gris quartzite
glazen wastafel - optiwhite / kwartsiet grijs



Mineralguss-Waschtisch, weiß
cast mineral washbasin, white
plan vasque en matériau de synthèse, blanc
minerale wastafel, wit

evermite®

evermite® Waschtisch, weiß
evermite® washbasin, white
evermite® plan vasque, blanc
evermite® wastafel, wit

764 / 164

Steingrau matt
stonegrey matt
gris pierre mat
steengrijs mat

777 / 177

Cosmos grey matt
cosmos grey matt
cosmos grey mat
cosmos grey mat

793 / 111

Edelweiß matt / Weiß matt
noble white matt / white matt
blanc pur mat / blanc mat
edelwit mat / wit mat

Frontdekore / Korpusdekore
Front finishes / Carcass colours
Façades / Corps de meuble
Front kleuren / Corpus kleuren

891 / 191

Quarzgrau matt
quartz grey matt
gris quartz mat
kwartsgrijs mat

893 / 193

Titangrau matt
titanium grey matt
titane gris mat
titanium grijs mat

686 / 121

Anthrazit hgl.
anthracite hgl.
anthracite haute brillance
hoogglans antraciet

722 / 161

Polarweiß hgl. / Weiß hgl.
polarwhite hgl. / white hgl.
blanc polaire haute brillance /
blanc haute brillance
hoogglans wit

680 / 180

Charleston Eiche
charleston oak
chêne Charleston
charleston eiken

784 / 184

Eiche hell Nachbildung
light oak effect
imitation chêne clair
licht eiken folie

785 / 185

Eiche natur Nachbildung
natural oak effect
imitation chêne naturel
eiken naturel folie

786 / 186

Eiche Trüffel
truffle oak
chêne truffier
eiken truffel

794 / 194

Eiche Sand
sand oak
chêne sable
zand eiken

792 / 192

Ulme Nachbildung
elm imitation
imitation orme
iepen hout folie

755 / 155

Hacienda Schwarz
hacienda black
noir exotique
hacienda zwart

769 / 169

Hacienda Grau
hacienda grey
gris exotique
hacienda grijs



Badmöbelkombinationen in 906, 1206 und 1406 mm Breite erhältlich.
Bathroom furniture combinations available in widths 906, 1206 and 1406 mm.
Compositions de salle de bains disponibles en largeur de 906, 1206 et 1406 mm.
Badkamermöbelcombinaties in 906, 1206 en 1406 mm breed verkrijgbaar.



puris
4life



Stangengriff chrom
handle chrome
poignée barre chrome
stangengreep chrom



Glas-Waschtisch - optiwhite / quarzitgrau
glass washbasin - optiwhite / quartzite grey
plan vasque en verre - optiwhite / gris quartzite
glazen wastafel - optiwhite / kwartsiet grijs



evermite®



evermite® Waschtisch, weiß
evermite® washbasin, white
evermite® plan vasque, blanc
evermite® wastafel, wit

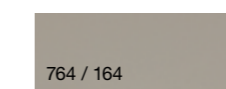

764 / 164
Steingrau matt
stonegrey matt
gris pierre mat
steengrijs mat

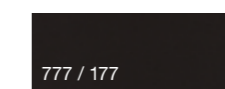

777 / 177
Cosmos grey matt
cosmos grey matt
cosmos grey mat
cosmos grey mat

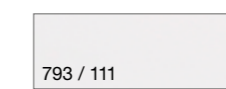

793 / 111
Edelweiß matt / Weiß matt
noble white matt / white matt
blanc pur mat / blanc mat
edelwit mat / wit mat

Frontdekore / Korpusdekore
Front finishes / Carcass colours
Façades / Corps de meuble
Front kleuren / Corpus kleuren

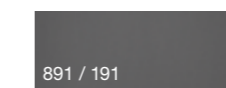

891 / 191
Quarzgrau matt
quarz grey matt
gris quartz mat
kwartsgrijs mat

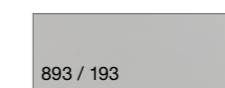

893 / 193
Titangrau matt
titanium grey matt
titane gris mat
titanium grijs mat

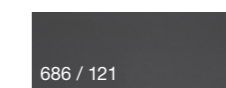

686 / 121
Anthrazit hgl.
anthracite hgl.
anthracite haute brillance
hoogglans antraciet



722 / 161
Polarweiß hgl. / Weiß hgl.
polarwhite hgl. / white hgl.
blanc polaire haute brillance /
blanc haute brillance
hoogglans wit



680 / 180
Charleston Eiche
charleston oak
chêne Charleston
charleston eiken

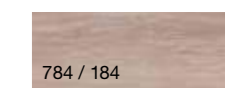

784 / 184
Eiche hell Nachbildung
light oak effect
imitation chêne clair
licht eiken folie



785 / 185
Eiche natur Nachbildung
natural oak effect
imitation chêne naturel
eiken naturel folie



786 / 186
Eiche Trüffel
truffie oak
chêne truffier
eiken truffel



794 / 194
Eiche Sand
sand oak
chêne sable
zand eiken



792 / 192
Ulme Nachbildung
elm imitation
imitation orme
iepen hout folie



755 / 155
Hacienda Schwarz
hacienda black
noir exotique
hacienda zwart



769 / 169
Hacienda Grau
hacienda grey
gris exotique
hacienda grijs

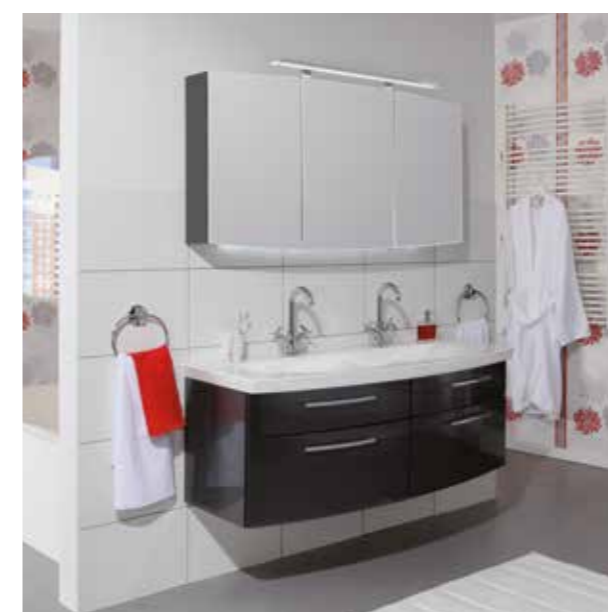

Badmöbelkombinationen in 712, 912, 1212 und 1412 mm Breite erhältlich. 1412 mm Breite auch als Doppelwaschtisch möglich (ausgenommen Glas).
Bathroom furniture combinations available in widths 712, 912, 1212 and 1412 mm. Width 1412 mm also available as double washbasin (except glass).
Compositions de salle de bains disponibles en largeur de 712, 912, 1212 et 1412 mm. Largeur de 1412 mm également comme plan double vasque (sauf verre).
Badkamermeubelcombinaties in 712, 912, 1212 en 1412 mm breed verkrijgbaar. 1412 mm breed ook als dubbele wastafel mogelijk (behalve glas).



puris
4life



Ideal Standard CONNECT AIR



Ideal Standard CUBE



„Málaga“



Villeroy&Boch LOOP



„Melbourne“



„Squared“



„Kingston“



„Perth“



grifflos mit Griffmulde
handleless with recessed grip
sans poignée avec prise de main
en creux
grypeloos met greeplijstfresing in
het front



Griffeiste - chrom / alu matt / schwarz matt
strip handle - chrome / alu matt / black matt
profilé poignée - chrome / alu mat / noir mat
grypelijst - chroom / alu mat / zwart mat



Villeroy&Boch LOOP



Villeroy&Boch MEMENTO CeramicPlus

Keramik-Aufsatzwaschtische, weiß
ceramic top-mounted washbasins, white
vasques à poser céramique, blanc
keramische opzetwastafels, wit

*Waschtisch ist erhältlich in verschiedenen Größen.
*Washbasin is available in different sizes.
*La vasque à poser est livrable en dimensions différentes.
*Wastafel is verkrijgbaar in verschillende afmetingen.

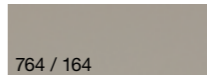

Steingrau matt
stonegrey matt
gris pierre mat
steengrijs mat

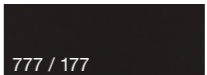

Cosmos grey matt
cosmos grey matt
cosmos grey mat
cosmos grey mat

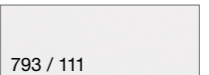

Edelweiß matt / Weiß matt
noble white matt / white matt
blanc pur mat / blanc mat
edelwit mat / wit mat

Frontdekore / Korpusdekore
Front finishes / Carcass colours
Façades / Corps de meuble
Front kleuren / Corpus kleuren

* Frontdekore nur grifflos
* Front finishes available only handleless
* Façades disponible sans poignée
* Front kleuren alleen grypeloos

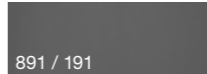

Quarzgrau matt
quartz grey matt
gris quartz mat
kwartsgrijs mat

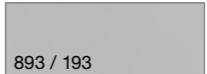

Titangrau matt
titanium grey matt
titane gris mat
titanium grijs mat

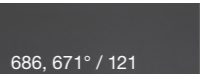

Anthrazit hgl.
anthracite hgl.
anthracite haute brillance
hoogglans antraciet

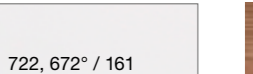

Polarweiß hgl. / Weiß hgl.
polarwhite hgl. / white hgl.
blanc polaire haute brillance /
blanc haute brillance
hoogglans wit

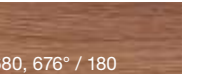

Charleston Eiche
charleston oak
chêne Charleston
charleston eiken

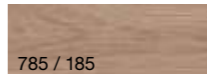

Eiche natur Nachbildung
natural oak effect
imitation chêne naturel
eiken naturel folie



Eiche Trüffel
truffle oak
chêne truffier
eiken truffel



Eiche Sand
sand oak
chêne sable
zand eiken



Ulme Nachbildung
elm imitation
imitation orme
lepen hout folie

Badmööbelkombinationen in 706, 1006, 1206, 1406 und 1706 mm Breite erhältlich. 1406 und 1706 mm Breite auch als Doppelwaschtisch möglich. Waschtischplatten in Korpusdekor maßflexibel bis 2600 mm.
Bathroom furniture combinations available in widths 706, 1006, 1206, 1406 and 1706 mm. Width 1406 and 1706 mm also available as double washbasin. Washbasin tops in Carcass colour are available in variable dimensions up to 2600 mm.
Compositions de salle de bains disponibles en largeur de 706, 1006, 1206, 1406 et 1706 mm. Largeur de 1406 et 1706 mm également comme plan double vasque. Plan de toilette pour vasque à poser, en couleur corps, possible jusqu'à 2600 mm.
Badkamermeubelcombinaties in 706, 1006, 1206, 1406 en 1706 mm breed verkrijgbaar. 1406 en 1706 mm breed ook leverbaar met 2 kraangaten of als dubbele wastafel. Houten wastafelplaten zijn verkrijgbaar in variabele lengte tot max. 2600 mm.

EXKLUSIV für Sie

EXCLUSIVELY for you

EXCLUSIF pour vous

EXKLUSIEF voor u

EXKLUSIV für Sie

EXCLUSIVELY for you

EXCLUSIF pour vous

EXKLUSIEF voor u

LED-Emotionbeleuchtung (Farbwechselsteuerung)*
LED-emotion colour change system*
Éclairage des émotions LED (capteur pour changement de couleur)*
LED-emotieverlichting (kleurverwisselbaar)*



kaltweiß
cool white
blanc froid
koudwit

LED

3 Helligkeitsstufen mit stufenlosem Farbwechsel
3 brightness levels with continuous colour change
3 niveaux de luminosité avec variation de couleur infirmement variable
kleurverandering van 3 kleuren led die naadloos in elkaar overgaan



warmweiß
warm white
blanc chaud
warmwit

*Gilt nur für bestimmte Artikel (siehe Typenliste).
*Valid only for some articles (see type list).
*Ne concerne que certains articles (voir liste des références).
*Geldt alleen voor bepaalde artikelen(zie de losse kasten).

Heizung für Spiegelflächen*
Heating for mirror surface*
Chauffage pour surfaces miroir*
Spiegelverwarming*



- nie wieder beschlagene Spiegel im Bad
- geringer Stromverbrauch
- automatische Abschaltung

- never again fogged up mirrors
- low power consumption
- automatic switching off

- plus jamais de buée sur le miroir de votre salle de bain
- faible consommation d'énergie
- connexion automatique

- nooit meer een beslagen spiegel in uw badkamer
- gering stroomverbruik
- automatische uitschakeling



*Gilt nur für bestimmte Artikel (siehe Typenliste).
*Valid only for some articles (see type list).
*Ne concerne que certains articles (voir liste des références).
*Geldt alleen voor bepaalde artikelen(zie de losse kasten).

STONE-PLUS® evermite®

Der besondere Schutz für Ihren Waschtisch. Mineralguss neu erleben.
Dank der einzigartigen Oberfläche.
The special protection for your washbasin.
Experience mineral cast in a new way, thanks to the unique surface.
La protection spéciale pour votre plan de toilette. Expérimenter un nouveau matériau de synthèse. Grâce à sa surface unique.
De bijzondere bescherming voor uw wastafel. Een minerale wastafel nieuw beleven.
Dankzij het unieke oppervlak.

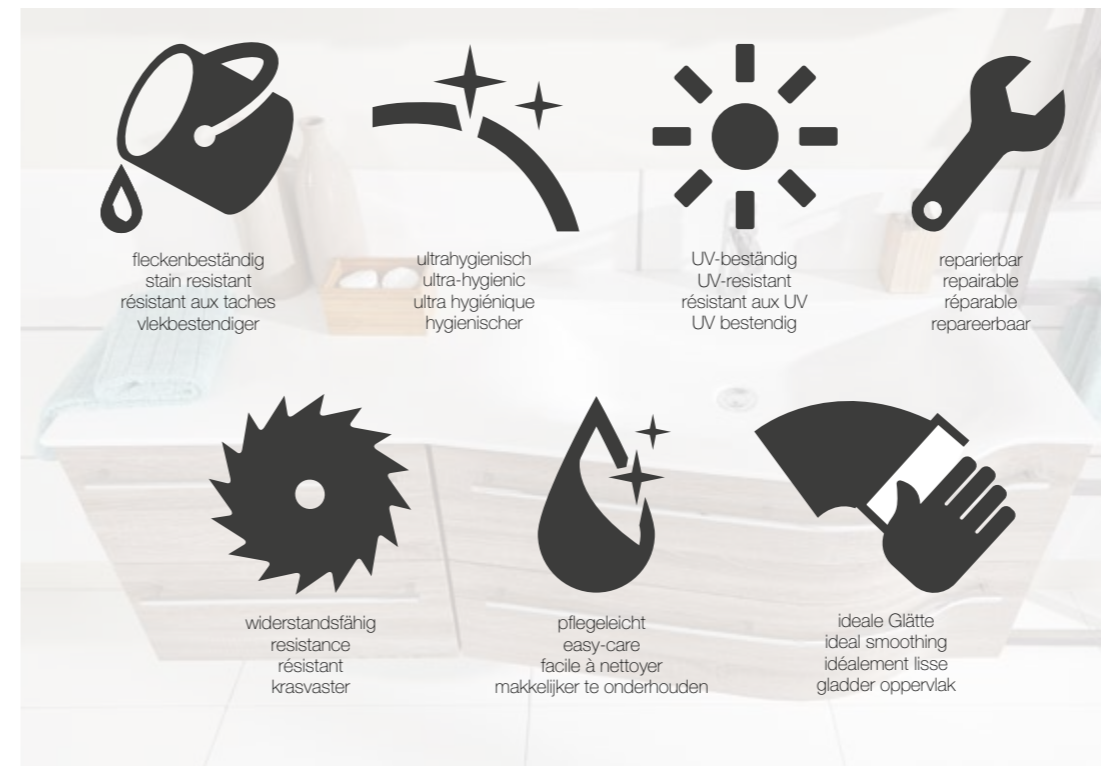

fleckenbeständig
stain resistant
résistant aux taches
vlekbestendig

ultrahygienisch
ultra-hygienic
ultra hygiénique
hygienischer

UV-beständig
UV-resistant
résistant aux UV
UV bestendig

reparierbar
repairable
réparable
repareerbaar

widerstandsfähig
resistance
résistant
krasvaster

pflegeleicht
easy-care
facile à nettoyer
makkelijker te onderhouden

ideale Glätte
ideal smoothing
idéalement lisse
gladder oppervlak

Bitte beachten Sie die Pflege- und Gebrauchshinweise.
Please follow the care and use instructions.
Veuillez à respecter les conseils d'entretien et de nettoyage.
Let u aub op de montage en gebruiksaanwijzingen.



Qsolid®

Dieses Waschtischplattenmaterial hat einen Quarzanteil von mehr als 90%, was dem Material eine außergewöhnliche Härte und Widerstandskraft verleiht. Die Quarzartikel werden in verschiedenen Körnungsgrößen geschichtet, verpresst und unter Wärmeinsatz verdichtet. So entsteht eine Arbeitsplatte aus Quarz mit bakteriostatischem Hygieneschutz.

This washbasin top material has a quartz content of more than 90%, which gives the material exceptional hardness and resistance. The quartz articles are layered in various grain sizes, pressed and compacted using heat. The result is a quartz worktop with bacteriostatic hygiene protection.

Le matériau du dessus de plans de toilette a une teneur en quartz de plus de 90%, ce qui lui confère une dureté et une résistance exceptionnelles. Les articles en quartz sont stratifiés en différentes granulométries, pressés et compactés à chaud. Le résultat est un plan de travail en quartz avec protection hygiénique bactériostatique.

Dit wastafelplaten materiaal heeft een kwartsgehalte van meer dan 90%, wat het materiaal een uitzonderlijke hardheid en weerstand geeft. De kwartsartikelen zijn gelaagd in verschillende korrelgroottes, geperst en verdicht met behulp van warmte. Het resultaat is een werkblad van kwarts met bacteriostatische hygiënische bescherming.



Optionales Zubehör + optionale Ergänzungsschränke
 optional accessoires + optional additional cabinets
 accessoires en option + meubles complémentaires
 optionele accessoires + losse kasten



ROUNDS

Planungsbeispiele
 Planning examples
 Exemples de composition
 Sets

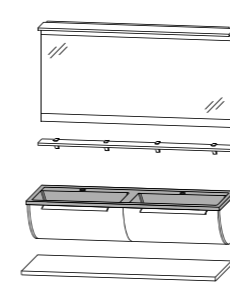

ROK-9814-1D
1432

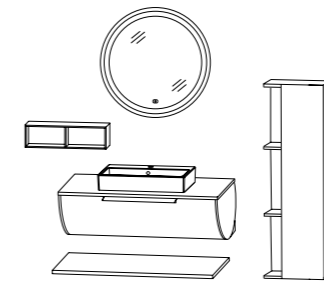

ROK-0190-1
926 + 400

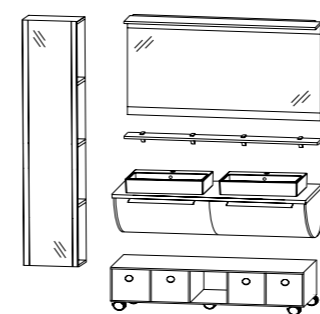

ROK-0114-1D
400 + 1426

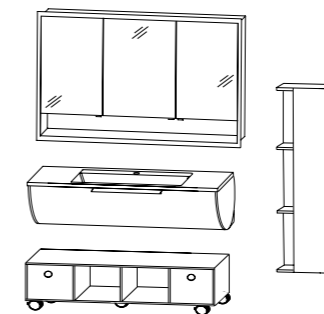

ROS-6112-1
1232 + 400

Türen / Auszüge / Schubkästen mit Dämpfung
 Doors / pull out units / drawers with buffered closing
 Portes / tiroirs / coulissants avec amortisseur
 Deuren en lades met softclose

MODERN LIFE

Planungsbeispiele
 Planning examples
 Exemples de composition
 Sets

Türen / Auszüge / Schubkästen mit Dämpfung
 Doors / pull out units / drawers with buffered closing
 Portes / tiroirs / coulissants avec amortisseur
 Deuren en lades met softclose

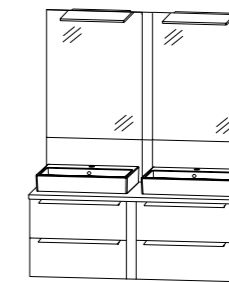

MLK-0112-1D
1266

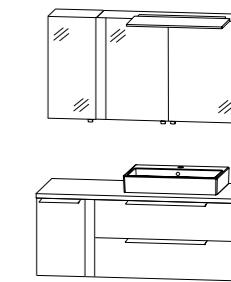

MLK-0112-2
1266

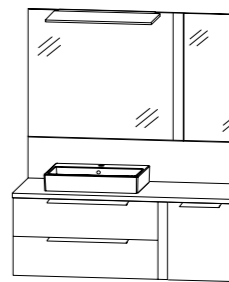

MLK-0113-1
1366

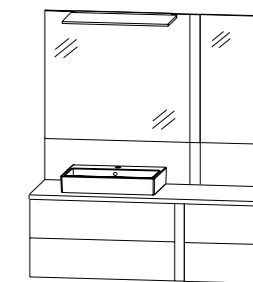

MLK-0115-1
1566

Abbildungen mit Griffleiste, auch in grifflos (push-to-open) möglich.
 Technical drawings with handle bar, also available handleless (push-to-open).
 Les exemples de composition avec profilé poignée également possible sans poignées (push-to-open).
 Afbeeldingen zijn met greeplijst, greeploos (push-to-open) zijn ook mogelijk.

Breite in mm
 Width in mm
 Largeur en mm
 Breedte in mm

Ergänzungsschränke - Auszug aus dem Typenplan
 Additional cabinets - part of the type list
 Meubles complémentaires - extrait du plan type
 Losse kasten - getoonde kasten zijn een selectie uit de kast mogelijkheden

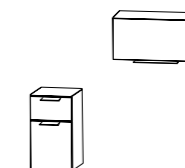

UNA-3230 L (R)
OMA-2160-K
300 x 480 / 600 x 320

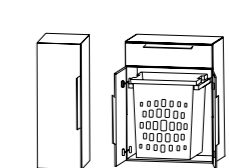

HBA-5130 L (R)
HBA-5560-1W
300 / 400 / 600 x 800

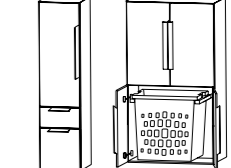

MNA-8830 L (R)
MNA-8360-1W
300 / 400 / 600 x 1280

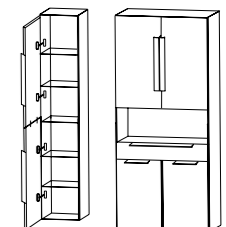

HNA-0330-11 L (R)
HNA-0260-01
300 / 400 / 600 x 1600

Abbildungen mit Griffleiste. Weitere Ergänzungsschränke finden Sie in der Typenliste.
 Technical drawings with handle bar. You will find more add-on units in the type list.
 Les exemples de composition avec profilé poignée. Autres armoires supplémentaires, voir catalogue.
 Afbeeldingen zijn met greeplijst. Meer bijpassende kasten vindt u in de typelijst.

Breite x Höhe in mm
 Width x height in mm
 Largeur x hauteur en mm
 Breedte x hoogte in mm

XPRESSION

Planungsbeispiele Spiegel - Auszug aus dem Typenplan

Planning proposals mirrors - part of the type list
Exemples de composition miroir et armoires de toilette miroir - extrait du plan type
Spiegelkasten - getoonde kasten zijn een selectie uit de kast mogelijkheden

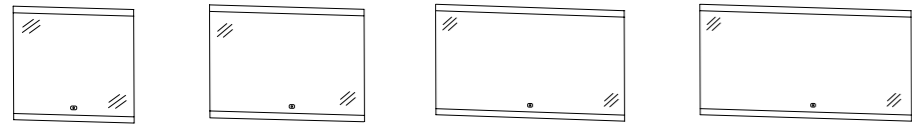

FSB-4360-01 600 x 640
FSB-4390-01 900 x 640
FSB-4312-01 1200 x 640
FSB-4314-01 1400 x 640

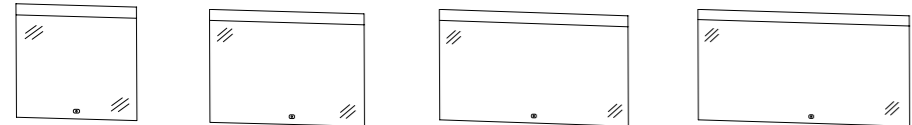

FSB-4360-02 600 x 640
FSB-4390-02 900 x 640
FSB-4312-02 1200 x 640
FSB-4314-02 1400 x 640

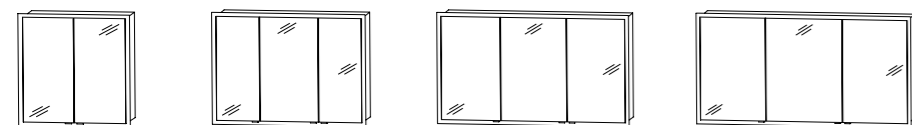

S2A-5360-E1 651 x 851
S2A-5390-E1 951 x 851
S2A-5312-E1 1251 x 851
S2A-5314-E1 1451 x 851

Planungsbeispiele Waschtische - Auszug aus dem Typenplan

Planning proposals washbasins - part of the type list
Exemples de composition plans vasque - extrait du plan type
Sets van wastafels en wastafelonderkasten - getoonde kasten zijn een selectie uit de kast mogelijkheden

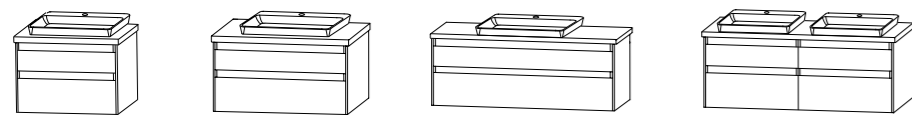

WTA-S111-1 WP-5063-FO SET-386S-2B 626 x 600
WTA-S111-1 WP-5093-FO SET-389S-2B 926 x 600
WTA-S111-1 WP-5123-FO SET-382S-2B 1226 x 600
2x WTA-S111-1 WP-5143-FO SET-3814-2B 1426 x 600

Ergänzungsschränke - Auszug aus dem Typenplan

Additional cabinets - part of the type list
Meubles complémentaires - extrait du plan type
Losse kasten - getoonde kasten zijn een selectie uit de kast mogelijkheden

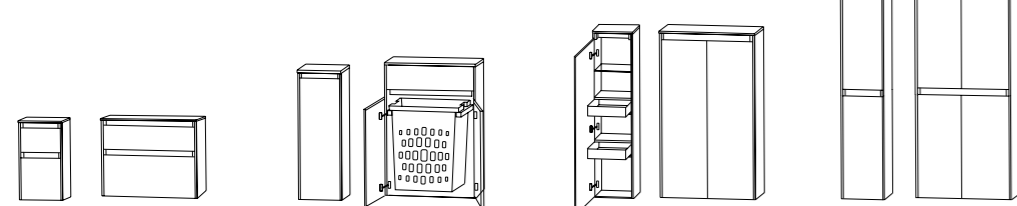

UNA-383D-GL UNA-386D-GL 322 / 622 x 490
HBA-513D-GL (L) HBA-556D-W/G 322 / 622 x 840
MNA-843D-GL L (R) MNA-816D-GL 322 / 622 x 1320
HNA-033D-GL L (R) HNA-036D-GL 320 / 620 x 1630

Türen / Auszüge / Schubkästen mit Dämpfung
Doors / pull out units / drawers with buffered closing
Portes / tiroirs / coulissants avec amortisseur
Deuren en lades met softclose

4LANDA

Planungsbeispiele Spiegel - Auszug aus dem Typenplan

Planning proposals mirrors - part of the type list
Exemples de composition miroir et armoires de toilette miroir - extrait du plan type
Spiegelkasten - getoonde kasten zijn een selectie uit de kast mogelijkheden

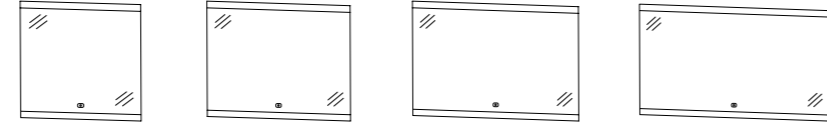

FSB-4360-01 600 x 640
FSB-4380-01 800 x 640
FSB-4310-01 1000 x 640
FSB-4312-01 1200 x 640

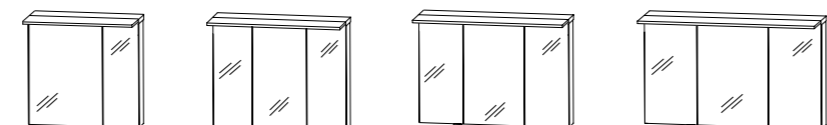

SET-4360-07 L (R) 600 x 660
SET-4380-07 800 x 660
SET-4310-07 1000 x 660
SET-4312-07 1200 x 660

Planungsbeispiele Waschtische - Auszug aus dem Typenplan

Planning proposals washbasins - part of the type list
Exemples de composition plans vasque - extrait du plan type
Sets van wastafels en wastafelonderkasten - getoonde kasten zijn een selectie uit de kast mogelijkheden

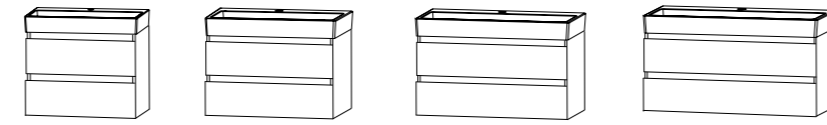

WTM-4806-1 WUA-4360-2G 620 x 690
WTM-4808-1 WUA-4380-2G 810 x 690
WTM-4810-1 WUA-4310-2G 1020 x 690
WTM-4812-1 WUA-4312-2G 1220 x 690

Abbildungen grifflos, auch mit Griffleiste möglich.
Technical drawings handleless, also available with strip handle.
Les exemples de composition sans poignées également possible avec profilé poignées.
Afbeeldingen zijn greeploos, met greeplijst zijn ook mogelijk.

WTM-4821-1 WUA-4310-2G 1020 x 690
WTM-482D-1 WUA-432D-2G 1220 x 690

Ergänzungsschränke - Auszug aus dem Typenplan

Additional cabinets - part of the type list
Meubles complémentaires - extrait du plan type
Losse kasten - getoonde kasten zijn een selectie uit de kast mogelijkheden

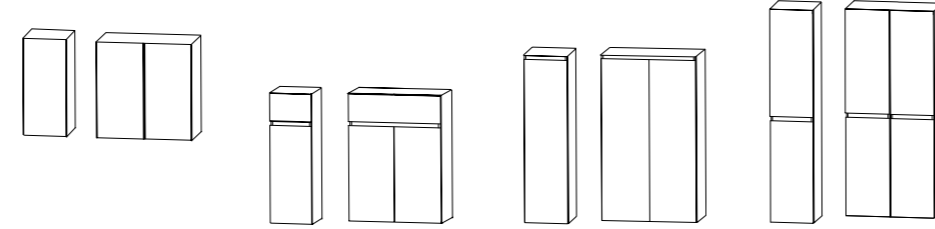

OGA-4130-TG L (R) OGA-4160-TG 300 / 600 x 640
HBA-5530-TG L (R) HBA-5560-TG 300 / 600 x 830
MNA-8130-TG L (R) MNA-8160-TG 300 / 600 x 1310
HNA-0330-TG L (R) HNA-0360-TG 300 / 600 x 1630

Breite x Höhe in mm
Width x height in mm
Largeur x hauteur en mm
Breedte x hoogte in mm

SLIM LINE

Planungsbeispiele Spiegel

Planning proposals mirrors
Exemples de composition miroir et armoires de toilette miroir
Spiegels / Spiegelkasten

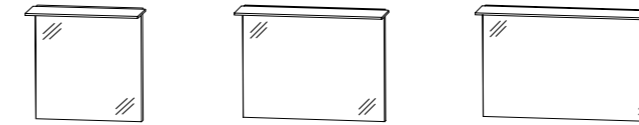

FSA-416B-29 600 x 640
FSA-419B-29 900 x 640
FSA-412B-29 1200 x 640

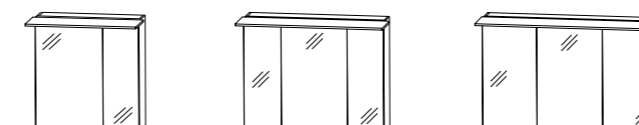

SDA-436L-01 (R) 600 x 640
SDA-4390-01 900 x 640
SDA-4312-01 1200 x 640



STA-436L-01 (R) 600 x 640
STA-4390-01 900 x 640
STA-4312-01 1200 x 640

Planungsbeispiele Waschtische

Planning proposals washbasins
Exemples de composition plans vasque
Sets van wastafels en wastafelonderkasten

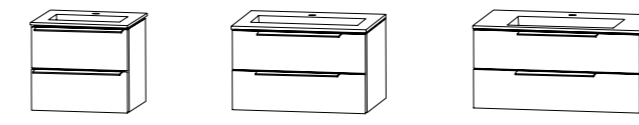

SET-SL60-MG 612 x 501
SET-SL90-MG 912 x 501
SET-SL12-MG 1212 x 501

STONEPLUS

Ergänzungsschränke - Auszug aus dem Typenplan

Additional cabinets - part of the type list
Meubles complémentaires - extrait du plan type
Losse kasten - getoonde kasten zijn een selectie uit de kast mogelijkheden

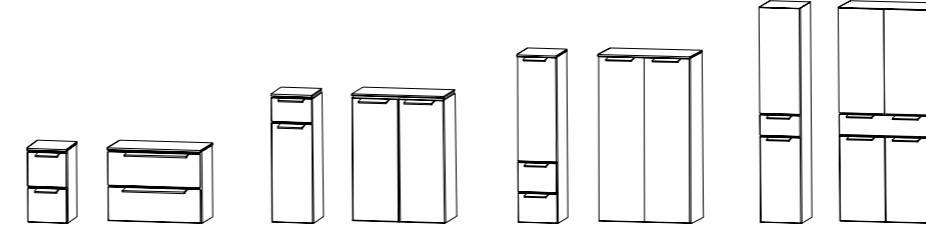

UNA-363A-29 UNA-366A-29 300 / 600 x 490
HBA-553A-29 L (R) HBA-516A-29 300 / 600 x 810
MNA-873A-29 L (R) MNA-816A-29 300 / 600 x 1290
HNA-0530-29 L (R) HNA-0560-29 300 / 600 x 1600

Breite x Höhe in mm
Width x height in mm
Largeur x hauteur en mm
Breedte x hoogte in mm

Türen / Auszüge / Schubkästen mit Dämpfung
Doors / pull out units / drawers with buffered closing
Portes / tiroirs / coulissants avec amortisseur
Deuren en lades met softclose

Abbildungen mit Griffleiste, auch in grifflos möglich.
Technical drawings with handle bar, also available handleless.
Les exemples de composition avec profilé poignées également possible sans poignées.
Afbeeldingen zijn met greeplijst, greeploos zijn ook mogelijk.

KAO LINE

Planungsbeispiele Spiegel

Planning proposals mirrors
Exemples de composition miroir et armoires de toilette miroir
Spiegelkasten

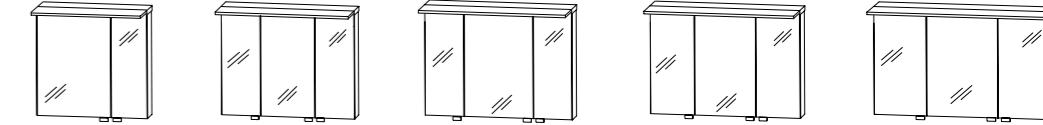

SET-4360-07 L (R) 600 x 660
SET-4380-07 800 x 660
SET-4390-07 900 x 660
SET-4310-07 1000 x 660
SET-4312-07 1200 x 660

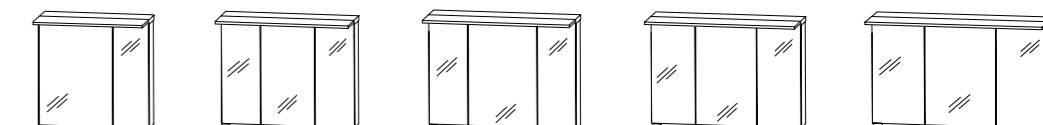

SET-4360-06 L (R) 600 x 660
SET-4380-06 800 x 660
SET-4390-06 900 x 660
SET-4310-06 1000 x 660
SET-4312-06 1200 x 660

Planungsbeispiele Waschtische

Planning proposals washbasins
Exemples de composition plans vasque
Sets van wastafels en wastafelonderkasten



SET-KL60-1 660 x 530
SET-KL80-1 860 x 530
SET-KL90-1 960 x 530
SET-KL10-1 1060 x 530
SET-KL12-1 1260 x 530

Keramik
ceramic
céramique
keramiek

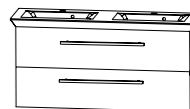

SET-KL12-D1 1260 x 530

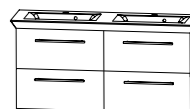

SET-KL2D-1 1260 x 530

Breite x Höhe in mm
Width x height in mm
Largeur x hauteur en mm
Breedte x hoogte in mm

Türen / Auszüge / Schubkästen mit Dämpfung
Doors / pull out units / drawers with buffered closing
Portes / tiroirs / coulissants avec amortisseur
Deuren en lades met softclose

ASPEKT

Planungsbeispiele
Planning examples
Exemples de composition
Sets

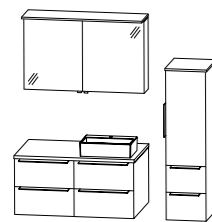

ASK-4312-2
1206 + 402

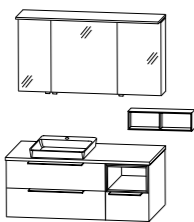

ASK-0113-1
1306

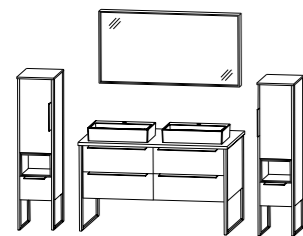

ASK-4312-1
343 + 1246 + 343

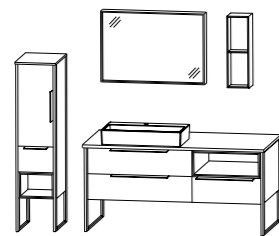

ASK-4315-1
342 + 1546

Breite in mm
Width in mm
Largeur en mm
Breedte in mm

Türen / Auszüge / Schubkästen mit Dämpfung
Doors / pull out units / drawers with buffered closing
Portes / tiroirs / coulissants avec amortisseur
Deuren en lades met softclose

Badmöbelkombinationen von 606 bis 1546 mm Breite erhältlich.
Bathroom furniture combinations available in widths from 606 to 1546 mm.
Compositions de salle de bains disponibles en largeur de 606 à 1546 mm.
Badkamermeubelcombinaties van 606 tot 1546 mm breed verkrijgbaar.

BRILLANT

Planungsbeispiele Spiegel
Planning proposals mirrors
Exemples de composition miroir et armoires de toilette miroir
Spiegelkasten

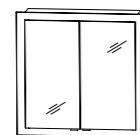

S2A-4360-51
720 x 760

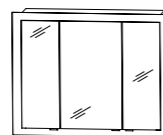

S2A-4390-51
1020 x 760

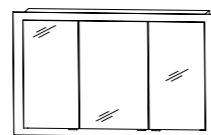

S2A-4312-51
1320 x 760

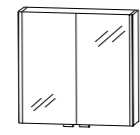

S2A-446B-04
600 x 640

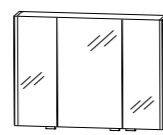

S2A-449B-04
900 x 640

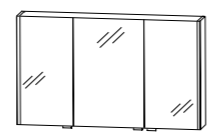

S2A-442B-04
1200 x 640

Breite x Höhe in mm
Width x height in mm
Largeur x hauteur en mm
Breedte x hoogte in mm

Türen / Auszüge / Schubkästen mit Dämpfung
Doors / pull out units / drawers with buffered closing
Portes / tiroirs / coulissants avec amortisseur
Deuren en lades met softclose

Planungsbeispiele Waschtische - Auszug aus dem Typenplan
Planning proposals washbasins - part of the type list
Exemples de composition plans vasque - extrait du plan type
Sets van wastafels en wastafelonderkasten - getoonde kasten zijn een selectie uit de kast mogelijkheden



SWM-9506-B3
WUA-3360-E9
606 x 510

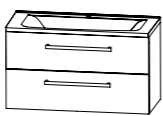

SWM-9509-B3
WUA-3390-E9
906 x 510

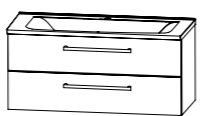

SWM-9512-B3
WUA-3312-E9
1206 x 510

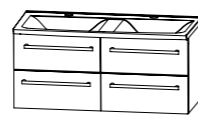

SWM-952D-B3
WUA-3312-9
1206 x 510

evermite®

Abbildungen mit evermite® Waschtisch, auch in Glas erhältlich.
Technical drawing with evermite® washbasin, also available in glass.
Les exemples de composition avec evermite® plan vasque sont également disponible en verre.
Afbeeldingen zijn met evermite® wastafels, glazen wastafels zijn ook mogelijk.

Ergänzungsschränke - Auszug aus dem Typenplan
Additional cabinets - part of the type list
Meubles complémentaires - extrait du plan type
Losse kasten - getoonde kasten zijn een selectie uit de kast mogelijkheden

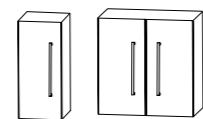

OGA-4130 L (R)
OGA-4160
300 / 600 x 640



UNA-3130-A1 L (R)
UNA-3660-A1
300 / 600 x 501



HBA-553W-A1
HBA-5160-A1
300 / 600 x 821

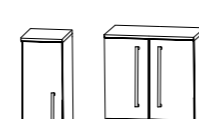

MNA-8130-A1 L (R)
MNA-836W-A2
300 / 600 x 1301

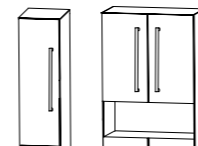

HNA-0530-01 L (R)
HNA-0260-02
300 / 600 x 1600

54

55

ICE LINE

Planungsbeispiele Spiegel
Planning proposals mirrors
Exemples de composition miroir et armoires de toilette miroir
Spiegels / Spiegelkasten

Breite x Höhe in mm
Width x height in mm
Largeur x hauteur en mm
Breedte x hoogte in mm

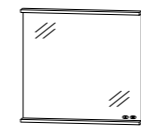

FSA-4360-89
600 x 672

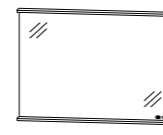

FSA-4390-89
900 x 672

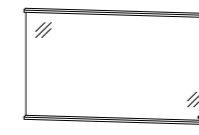

FSA-4312-89
1200 x 672

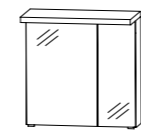

S2A-436L-89
600 x 650

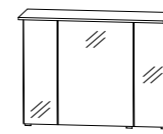

S2A-439A-89
900 x 650

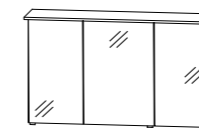

S2A-431A-89
1200 x 650

Abbildungen mit Griffleiste, auch in Grifflos (push-to-open) möglich.
Technical drawings with handle bar, also available handleless (push-to-open).
Les exemples de composition avec profilé poignée également possible sans poignées (push-to-open).
Afbeeldingen zijn met greeplijst, greeploos (push-to-open) zijn ook mogelijk.

Planungsbeispiele Waschtische
Planning proposals washbasins
Exemples de composition plans vasque
Sets van wastafels en wastafelonderkasten

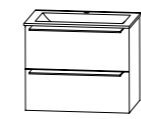

WMS-5060-61
WUA-3360-30
620 x 495

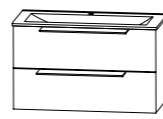

WMS-5090-61
WUA-3390-30
920 x 495

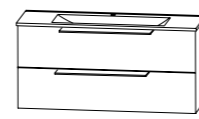

WMS-5120-61
WUA-3312-30
1220 x 495

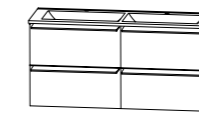

WMS-7120-61
WUA-332D-30
1220 x 495

STONEPLUS®

Abbildungen mit STONEPLUS® Waschtisch, auch in Glas erhältlich.
Technical drawing with STONEPLUS® washbasin, also available in glass.
Exemples de composition avec STONEPLUS® plan vasque, également disponible en verre.
Afbeeldingen zijn met STONEPLUS® wastafels, glazen wastafels zijn ook mogelijk.

Ergänzungsschränke - Auszug aus dem Typenplan
Additional cabinets - part of the type list
Meubles complémentaires - extrait du plan type
Losse kasten - getoonde kasten zijn een selectie uit de kast mogelijkheden

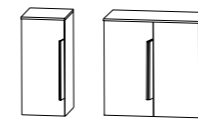

OGA-413A-3 L (R)
OGA-416A-3
308 / 608 x 646



UNA-313A-3 L (R)
UNA-316A-3
308 / 608 x 486

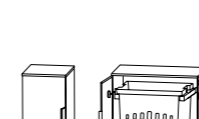

HBA-513A-3 L (R)
HBA-516W-A3
308 / 608 x 806

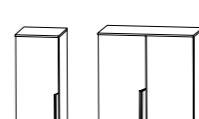

MNA-813A-3 L (R)
MNA-816A-3
308 / 608 x 1286

SWING

Planungsbeispiele Spiegel
Planning proposals mirrors
Exemples de composition miroir et armoires de toilette miroir
Spiegelkasten

Breite x Höhe in mm
Width x height in mm
Largeur x hauteur en mm
Breedte x hoogte in mm

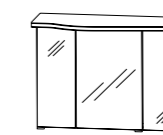

SET-4390-3 R (L)
900 x 680

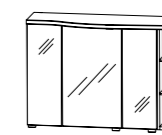

SET-4112-3R (L)
1200 x 680

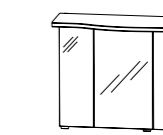

SET-4014-3R (L)
1400 x 680

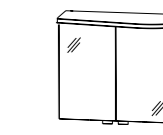

SET-4118-3
1800 x 680

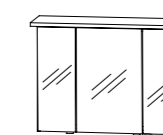

SET-4390-2
900 x 680

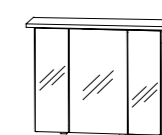

SET-4012-2R (L)
1200 x 680

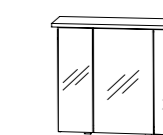

SET-4114-2R (L)
1400 x 680

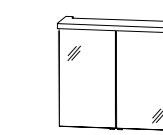

SET-4018-2 L (R)
1800 x 680

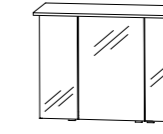

SET-4390-6
900 x 660

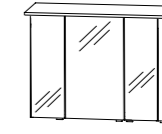

SET-4012-6R (L)
1200 x 660

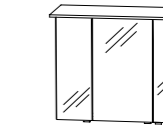

SET-4114-6R (L)
1400 x 660

Planungsbeispiele Waschtische
Planning proposals washbasins
Exemples de composition plans vasque
Sets van wastafels en wastafelonderkasten

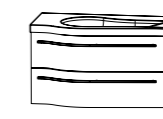

WMM-529R-21 (L)
WUA-3690-1M R (L)
906 x 495

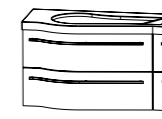

WMM-522R-21 (L)
WUA-3690-1M R (L) + UTA-3630-1M
1206 x 495

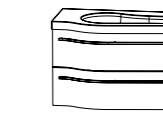

WMM-524R-21 (L)
WUA-3690-1M R (L) + UTA-3650-1M
1406 x 495

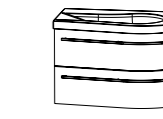

WMM-528D-21
WUA-3690-1M L + WUA-3690-1M R
1806 x 495

evermite®

Abbildungen mit evermite® Waschtisch, auch in Glas erhältlich.
Technical drawing with evermite® washbasin, also available in glass.
Les exemples de composition avec evermite® plan vasque sont également disponible en verre.
Afbeeldingen zijn met evermite® wastafels, glazen wastafels zijn ook mogelijk.

Türen / Auszüge / Schubkästen mit Dämpfung
Doors / pull out units / drawers with buffered closing
Portes / tiroirs / coulissants avec amortisseur
Deuren en lades met softclose

FINE LINE

Planungsbeispiele Spiegel
 Planning proposals mirrors
 Exemples de composition miroir et armoires de toilette miroir
 Spiegelkasten

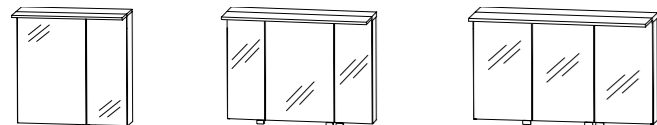

S2A-4360-78 L (R) 602 x 659
 S2A-4390-78 902 x 659
 S2A-4312-78 1202 x 659

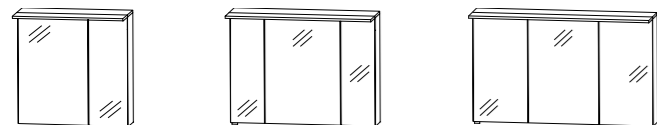

S2A-436S-08 L (R) 602 x 659
 S2A-439S-08 902 x 659
 S2A-432S-08 1202 x 659

Planungsbeispiele Waschtische
 Planning proposals washbasins
 Exemples de composition plans vasque
 Sets van wastafels en wastafelonderkasten



WMS-4060-61
 WUA-3760-28 620 x 495
 WMS-4090-61
 WUA-3790-28 920 x 495
 WMS-4120-61
 WUA-3712-28 1220 x 495

STONEPLUS®



WTK-7065-1
 WUA-3760-27 650 x 545
 WTK-7095-1
 WUA-3790-27 950 x 545
 WTK-7125-1
 WUA-3712-27 1250 x 545

Keramik
 ceramic
 céramique
 keramiek

Breite x Höhe in mm
 Width x height in mm
 Largeur x hauteur en mm
 Breedte x hoogte in mm

Türen / Auszüge / Schubkästen mit Dämpfung
 Doors / pull out units / drawers with buffered closing
 Portes / tiroirs / coulissants avec amortisseur
 Deuren en lades met softclose

CRESCENDO

Planungsbeispiele Spiegel
 Planning proposals mirrors
 Exemples de composition miroir et armoires de toilette miroir
 Spiegels / Spiegelkasten

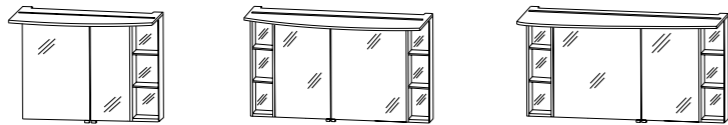

S2A-439R 76 (L) 900 x 650
 S2A-4312-76 L (R) 1200 x 650
 S2A-4314-76 R (L) 1400 x 650

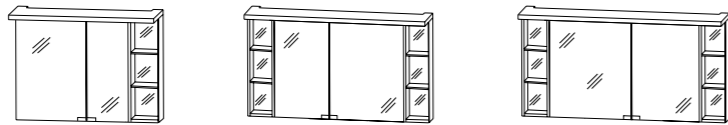

S2A-439R-26 (L) 900 x 668
 S2A-4312-26 L (R) 1200 x 668
 S2A-4314-26 R (L) 1400 x 668

Planungsbeispiele Waschtische
 Planning proposals washbasins
 Exemples de composition plans vasque
 Sets van wastafels en wastafelonderkasten



SWM-109L-1 (R) WUA-3690-09 L (R) 906 x 510
 SWM-112R-1 (L) WUA-3612-09 R (L) 1206 x 510
 SWM-114R-1 (L) WUA-3614-09 R (L) 1406 x 510

Mineralguss
 cast mineral
 matériau de synthèse
 mineraalmarmer

Breite x Höhe in mm
 Width x height in mm
 Largeur x hauteur en mm
 Breedte x hoogte in mm

Türen / Auszüge / Schubkästen mit Dämpfung
 Doors / pull out units / drawers with buffered closing
 Portes / tiroirs / coulissants avec amortisseur
 Deuren en lades met softclose

Abbildungen mit Mineralguss-Waschtisch, auch in evermite® oder Glas erhältlich.
 Technical drawing with cast mineral washbasin, also available in evermite® or glass.
 Les exemples de composition avec plan vasque en matériau de synthèse sont également disponible en evermite® ou en verre.
 Afbeeldingen zijn met minerale wastafels, evermite® en glazen wastafels zijn ook mogelijk.

COOL LINE

Planungsbeispiele Spiegel
 Planning proposals mirrors
 Exemples de composition miroir et armoires de toilette miroir
 Spiegelkasten

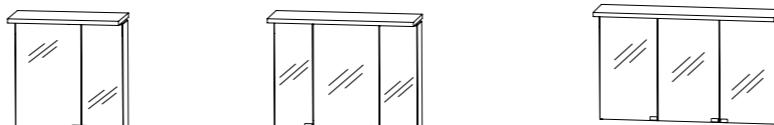

S2A-436A-20 L (R) 600 x 680
 S2A-439A-20 900 x 680
 S2A-431A-20 1200 x 680

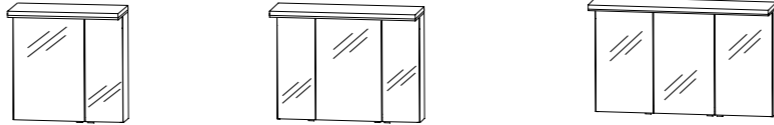

S2A-436A-69 L (R) 600 x 680
 S2A-439A-69 900 x 680
 S2A-431A-69 1200 x 680

Planungsbeispiele Waschtische
 Planning proposals washbasins
 Exemples de composition plans vasque
 Sets van wastafels en wastafelonderkasten

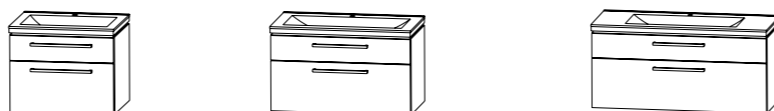

WMS-5060-61 WUA-386D-1M 620 x 539
 WMS-5090-61 WUA-389D-1M 920 x 539
 WMS-5120-61 WUA-381D-1M 1220 x 539

STONEPLUS®

Breite x Höhe in mm
 Width x height in mm
 Largeur x hauteur en mm
 Breedte x hoogte in mm

Türen / Auszüge / Schubkästen mit Dämpfung
 Doors / pull out units / drawers with buffered closing
 Portes / tiroirs / coulissants avec amortisseur
 Deuren en lades met softclose

Abbildungen mit STONEPLUS® Waschtisch, auch in Glas oder Keramik erhältlich.
 Technical drawing with STONEPLUS® washbasin, also available in glass or ceramic.
 Exemples de composition avec STONEPLUS® plan vasque sont également disponible en verre ou en céramique.
 Afbeeldingen zijn met STONEPLUS® wastafels, glazen en keramische wastafels zijn ook mogelijk.

STAR LINE

Planungsbeispiele Spiegel
 Planning proposals mirrors
 Exemples de composition miroir et armoires de toilette miroir
 Spiegels / Spiegelkasten



FSB-4190-01 900 x 652
 FSB-4112-01 1200 x 652
 FSB-4114-01 1400 x 652

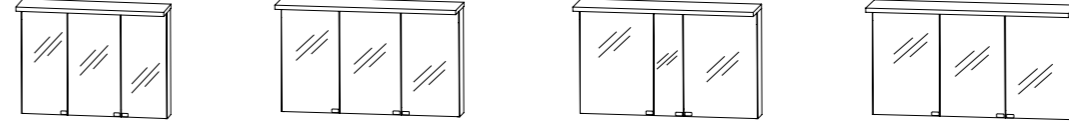

S2A-4390-16 900 x 668
 S2A-4312-16 1200 x 668
 S2A-4312-15 1200 x 668
 S2A-4314-16 1400 x 668
 S2A-4314-15 1400 x 668
 S2A-4316-15 1600 x 668

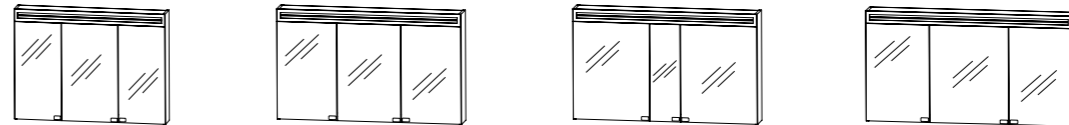

S2A-5890-6 900 x 720
 S2A-5812-6 1200 x 720
 S2A-5812-5 1200 x 720
 S2A-5814-6 1400 x 720
 S2A-5814-5 1400 x 720
 S2A-5816-5 1600 x 720

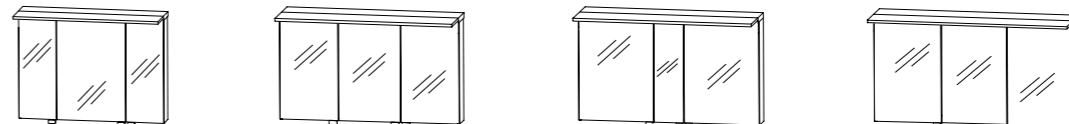

S2A-4390-78 900 x 660
 S2A-4312-78 1200 x 660
 S2A-4312-77 1200 x 660
 S2A-4314-78 1400 x 660
 S2A-4314-77 1400 x 660
 S2A-4316-77 1600 x 660

Planungsbeispiele Waschtische
 Planning proposals washbasins
 Exemples de composition plans vasque
 Sets van wastafels en wastafelonderkasten

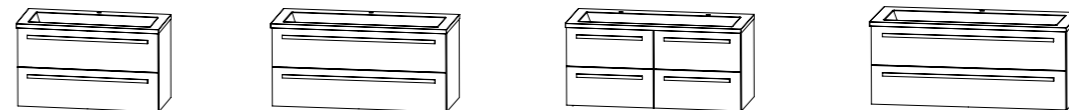

WME-919E-61 WUA-3390-07 906 x 498
 WME-912E-61 WUA-3312-07 1206 x 498
 WME-912D-61 WUA-3312-7 1206 x 498
 WME-914E-61 WUA-3314-07 1406 x 498
 WME-914D-61 WUA-3314-7 1406 x 498
 WME-916D-61 WUA-3316-7 1606 x 498

Breite x Höhe in mm
 Width x height in mm
 Largeur x hauteur en mm
 Breedte x hoogte in mm

Türen / Auszüge / Schubkästen mit Dämpfung
 Doors / pull out units / drawers with buffered closing
 Portes / tiroirs / coulissants avec amortisseur
 Deuren en lades met softclose

Abbildungen mit STONEPLUS® Waschtisch, auch in „evermite“ oder Glas erhältlich.
 Technical drawing with STONEPLUS® washbasin, also available in „evermite“ or glass.
 Les exemples de composition avec STONEPLUS® plan vasque sont également disponible en „evermite“ ou en verre.
 Afbeeldingen zijn met STONEPLUS® wastafels, „evermite“ en glazen wastafels zijn ook mogelijk.

STONEPLUS®

CLASSIC LINE

Planungsbeispiele Spiegel
 Planning proposals mirrors
 Exemples de composition miroir et armoires de toilette miroir
 Spiegelkasten

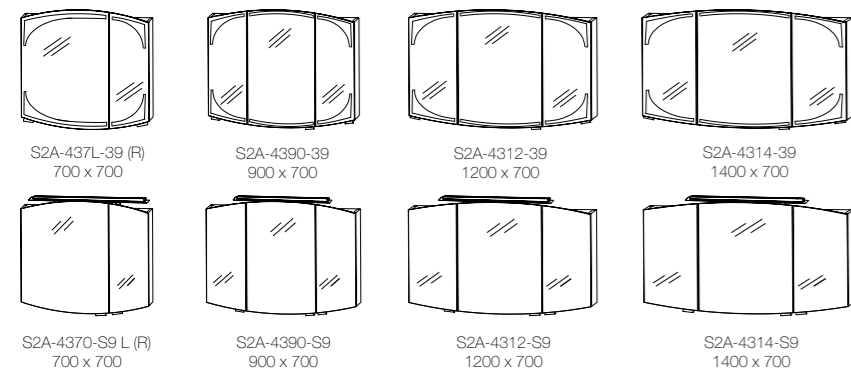

S2A-437L-39 (R) 700 x 700
 S2A-4390-39 900 x 700
 S2A-4312-39 1200 x 700
 S2A-4314-39 1400 x 700
 S2A-4370-S9 L (R) 700 x 700
 S2A-4390-S9 900 x 700
 S2A-4312-S9 1200 x 700
 S2A-4314-S9 1400 x 700

Planungsbeispiele Waschtische
 Planning proposals washbasins
 Exemples de composition plans vasque
 Sets van wastafels en wastafelonderkasten

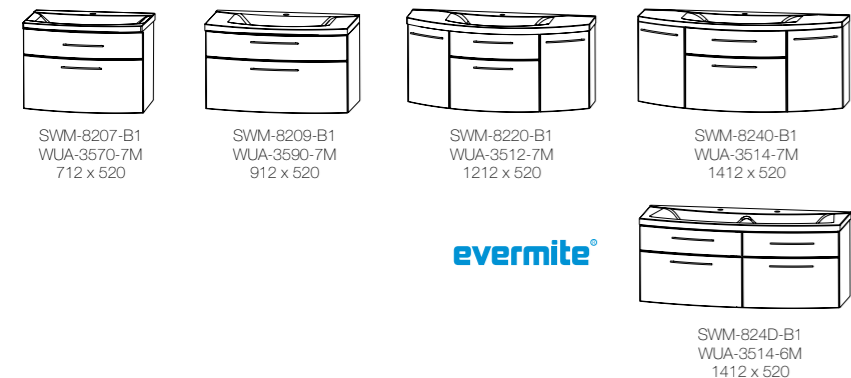

SWM-8207-B1 WUA-3570-7M 712 x 520
 SWM-8209-B1 WUA-3590-7M 912 x 520
 SWM-8220-B1 WUA-3512-7M 1212 x 520
 SWM-8240-B1 WUA-3514-7M 1412 x 520
 SWM-824D-B1 WUA-3514-6M 1412 x 520

evermite®

Breite x Höhe in mm
 Width x height in mm
 Largeur x hauteur en mm
 Breedte x hoogte in mm

Türen / Auszüge / Schubkästen mit Dämpfung
 Doors / pull out units / drawers with buffered closing
 Portes / tiroirs / coulissants avec amortisseur
 Deuren en lades met softclose

Abbildungen mit evermite® Waschtisch, auch in Glas erhältlich.
 Technical drawing with evermite® washbasin, also available in glass.
 Les exemples de composition avec evermite® plan vasque sont également disponible en en verre.
 Afbeeldingen is met evermite® wastafels, glazen wastafels zijn ook mogelijk.

VARIADO 2.0

Planungsbeispiele
 Planning examples
 Exemples de composition
 Sets

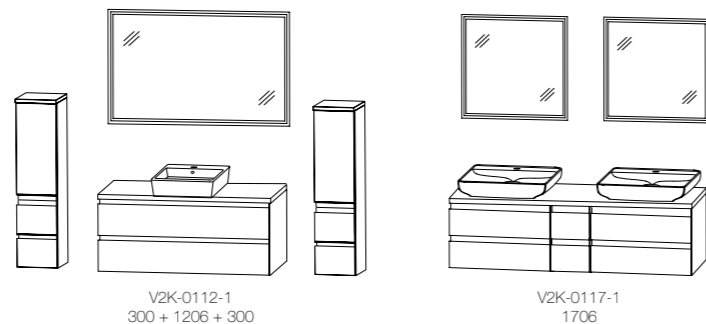

V2K-0112-1 300 + 1206 + 300
 V2K-0117-1 1706

Breite in mm
 Width in mm
 Largeur en mm
 Breedte in mm

Keramik
 ceramic
 céramique
 keramiek

Badmöbelkombinationen in 706, 1006, 1206, 1406 und 1706 mm Breite erhältlich.
 Bathroom furniture combinations available in widths 706, 1006, 1206, 1406 and 1706 mm.
 Compositions de salle de bains disponibles en largeur de 706, 1006, 1206, 1406 et 1706 mm.
 Badkamermeubelcombinaties in 706, 1006, 1206, 1406 en 1706 mm breed verkrijgbaar.

Abbildungen grifflos, auch mit Griffleiste möglich.
 Technical drawings handleless, also available with strip handle.
 Les exemples de composition sans poignées également possible avec profilé poignées.
 Afbeeldingen zijn greeploos, met greeplijst zijn ook mogelijk.

Planungsbeispiele Unterschranke
 Planning proposals base units
 Exemples de composition éléments sous plan vasque
 Onderkasten breedtes

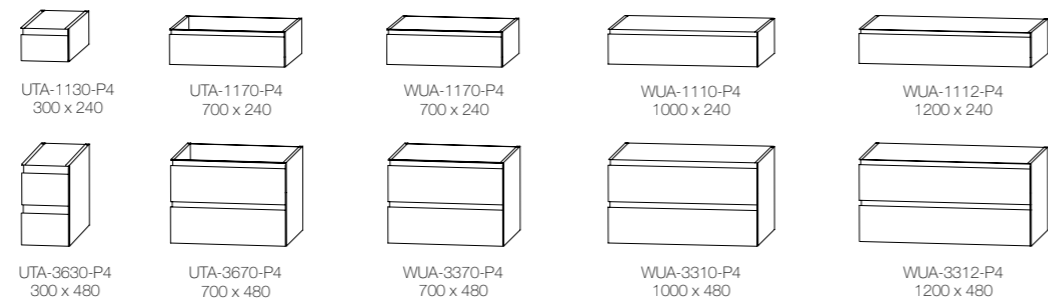

UTA-1130-P4 300 x 240
 UTA-1170-P4 700 x 240
 WUA-1170-P4 700 x 240
 WUA-1110-P4 1000 x 240
 WUA-1112-P4 1200 x 240
 UTA-3630-P4 300 x 480
 UTA-3670-P4 700 x 480
 WUA-3370-P4 700 x 480
 WUA-3310-P4 1000 x 480
 WUA-3312-P4 1200 x 480

Ergänzungsschränke - Auszug aus dem Typenplan
 Additional cabinets - part of the type list
 Meubles complémentaires - extrait du plan type
 Losse kasten - getoonde kasten zijn een selectie uit de kast mogelijkheden

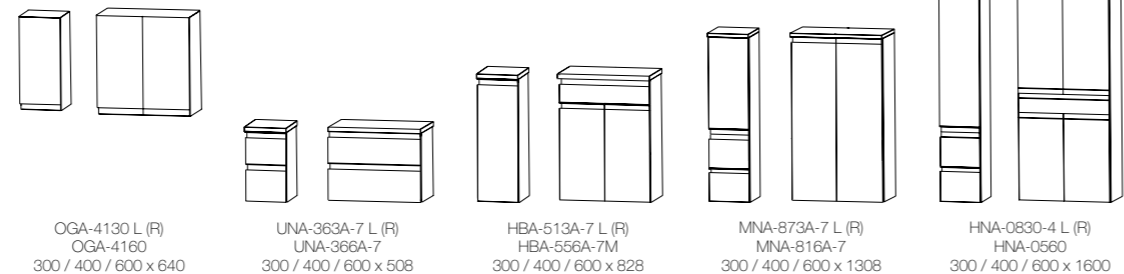

OGA-4130 L (R) OGA-4160 300 / 400 / 600 x 640
 UNA-363A-7 L (R) UNA-366A-7 300 / 400 / 600 x 508
 HBA-513A-7 L (R) HBA-556A-7M 300 / 400 / 600 x 828
 MNA-873A-7 L (R) MNA-816A-7 300 / 400 / 600 x 1308
 HNA-0830-4 L (R) HNA-0560 300 / 400 / 600 x 1600

STAR LINE

Ergänzungsschränke - Auszug aus dem Typenplan
 Additional cabinets - part of the type list
 Meubles complémentaires - extrait du plan type
 Losse kasten - getoonde kasten zijn een selectie uit de kast mogelijkheden



300 / 400 / 600 x 1628
 300 / 400 / 600 x 1628
 300 / 400 / 600 x 1628
 300 / 400 / 600 x 1628
 300 / 400 / 600 x 1628
 300 x 1600
 400 x 1600
 600 x 1628

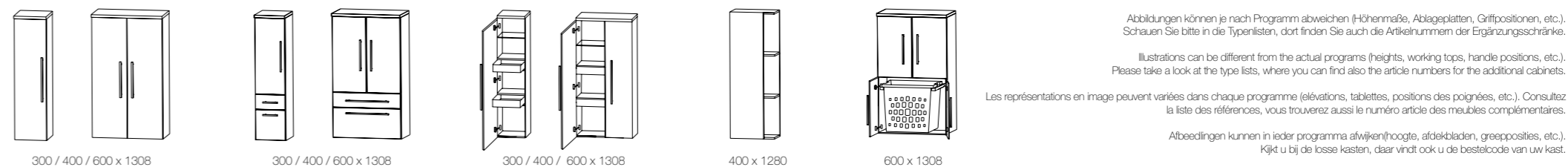

300 / 400 / 600 x 1308
 300 / 400 / 600 x 1308
 300 / 400 / 600 x 1308
 400 x 1280
 600 x 1308

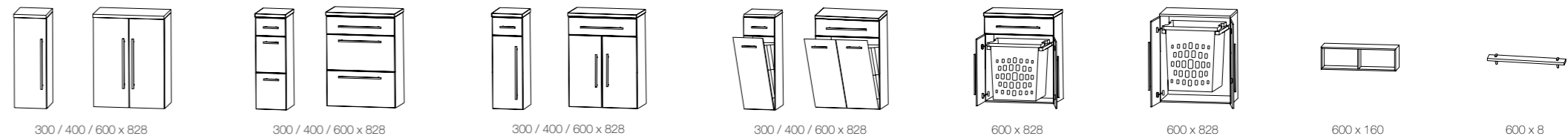

300 / 400 / 600 x 828
 300 / 400 / 600 x 828
 300 / 400 / 600 x 828
 300 / 400 / 600 x 828
 600 x 828
 600 x 828
 600 x 160
 600 x 8

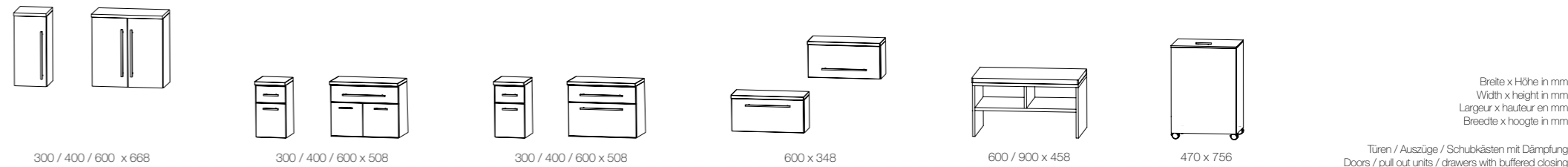

300 / 400 / 600 x 668
 300 / 400 / 600 x 508
 300 / 400 / 600 x 508
 600 x 348
 600 / 900 x 458
 470 x 756

Breite x Höhe in mm
 Width x height in mm
 Largeur x hauteur en mm
 Breedte x hoogte in mm

Türen / Auszüge / Schubkästen mit Dämpfung
 Doors / pull out units / drawers with buffered closing
 Portes / tiroirs / coulissants avec amortisseur
 Deuren en lades met softclose

CLASSIC LINE

KAO LINE

COOL LINE

SWING

for guests



Weitere Möbel finden Sie in den Prospekten „KeraPLAN“ und „for guests“.
Further bathroom furniture can be found in our brochures "KeraPLAN" and "for guests".
Vous trouverez plus de meubles dans les brochures «KeraPLAN» et «for guests».
Meer meubels zijn te vinden in de brochures "KeraPLAN" en "for guests".



Qualität ist Aufgabe und Ziel.
Das „goldene M“ steht für geprüfte Qualität, garantierte Sicherheit und gesundes Wohnen. Es ist das einzige in Deutschland offiziell anerkannte Gütezeichen für Möbel und es ist der strengste Nachweis für überprüfte Möbelqualität und -sicherheit in Europa.

Quality is our mission and goal.
The "Golden M" stands for tested quality, guaranteed safety and healthy living. It is Germany's only officially recognised quality seal for furniture and it is the strictest confirmation of tested furniture quality and safety in Europe.

Notre objectif: la qualité.
Le «M d'or» garantit non seulement une qualité et une sécurité contrôlée mais aussi un habitat sain. Il est le seul label de qualité attribué aux meubles reconnu en Allemagne. En Europe, suite à une série de tests réalisés, ce cachet est la garantie optimale de la qualité et la sécurité des meubles.

Kwaliteit is onze taak en doelstelling.
De "gouden M" staat voor geteste kwaliteit, veiligheid en gezond wonen gegarandeerd. Het is het enige officiële erkende label in Duitsland. Dit label geeft aan dat puris voldoet aan de strengste eisen van kwaliteit en veiligheid in Europa.



puris Bad GmbH & Co. KG · Hintern Gallberg 6a · D-59929 Brilon
mail@puris.de · www.puris.de

Abbildungen und Angaben sind unverbindlich. Technische Änderungen vorbehalten.
Illustrations and specifications are without obligation. Technical modifications reserved.
Reproductions et données techniques sans engagement de notre part. Sous réserve de modifications techniques.
Afbeldingen en specificaties kunnen afwijken. Technische wijzigingen voorbehouden.



KeraPLAN

puris
4life

spirit of bathrooms

